

Contact Information

WE'RE ALWAYS HERE TO HELP

We are here for you. At PABCO® Gypsum, technical support is one of the most important services we provide to the building community. Our technical services team is staffed by some of the most experienced professionals in the field.

QuietRock® and PABCO® Gypsum prides itself on the unsurpassed expertise that we offer our customers: architects, engineers, contractors, distributors and owners. Our team of experts are available to answer your questions and assist in the selection of the right product for your project.

Acoustical Product Technical Support

Phone: 800-797-8159

Email: info@QuietRock.com

Fire and Installation Technical Support

Phone: 866-282-9298

Email: techservices@PABCOgypsum.com



PABCO Gypsum
PO Box 419074
Rancho Cordova, CA 95741
www.PABCOgypsum.com



QuietRock
37851 Cherry Street
Newark, CA 94560
www.QuietRock.com

Introduction

The Sound Design Guide by PABCO® Gypsum, is the industry's most comprehensive and transparent resource for sound and fire information. It contains 177 sound and fire tested assemblies on various steel and wood-framed partitions, using various stud thicknesses, configurations and materials. Our assemblies, using both traditional gypsum wallboard and our QuietRock® sound reducing drywall, have been tested for both fire and sound, so you don't have to guess the STC performance when you build to the fire-rated designs.

New in this Edition

The 2022 edition includes the following enhanced features:

- 74 new designs added in every category
- New 2x6 wood stud framing section
- New numbering system to make designs easier to find
- Updated layout showing side-by-side comparisons of 16 oc and 24 oc results
- Emphasis on mil thickness for steel studs for greater accuracy of STC results and lower risk of field failure
- Updated tests on current assemblies
- Enhanced educational section with additional sound and fire information

Objectives for the Guide

The construction industry creates several handbooks designed to navigate and execute the correct assembly for specific fire requirements and includes STC ranges, when available. Although many assemblies found in current handbooks are sound tested, finding the sound rated wall that also meets fire ratings is often a confusing, if not a misleading proposition.

The Sound Design Guide provides details on sound rated assemblies which in some cases, are different than how the assembly was built for the fire test. In instances where there is a difference, the variance has been noted, so you can make the choice to build for sound or if a fire rating is required, build for fire and know that if tested for sound, results may vary. The differences that you will find relate only to screw length and screw spacing.

Secondly, sound isolation measurements and testing standards have been continuously revised since their inception decades ago. Yet, old tests using outdated methodologies are still out there in commonly used designs. They linger in design templates that have not been updated because "that is the way they've always done it." The Gypsum Association has determined that acoustic testing more than 30 years old is no longer valid and has been removing these old acoustic tests from the GA-600, Fire Resistance and Sound Control Design Manual. The tested assemblies in The Sound Design Guide are based on the most current testing methodologies, building techniques and materials available today.

In addition to the numerous tested assemblies, The Sound Design Guide also contains general acoustic information that may be helpful to you—from basic sound information to navigating test reports. PABCO® Gypsum is committed to providing you with a complete resource for designing sound and fire-rated assemblies in wall designs.



Build Your Reputation With Confidence

We make it easy!

Your business is built on your reputation. Trusted products and processes are critical to your success. PABCO® Gypsum makes one part of the construction process easier. Rely on our family of drywall products when you need:

- ✓ ***unmatched performance***
- ✓ ***helpful technical support***
- ✓ ***useful tools and resources***
- ✓ ***fire/sound design expertise***
- ✓ ***reliable test data***

Industry-leading service and support our customers swear by. PABCO® Gypsum — there's no substitute.

It's easy! Call or visit us online to learn more.



Legendary
QuietRock®

Dual-Purpose
MOLD CURB®

Trusted
FLAME CURB®

Protective
PABCO GLASS®

Versatile
ABUSE CURB®

Table of Contents

GENERAL INFORMATION

Introduction	3
About PABCO Gypsum	6
Guide Overview & General Notes	7
PABCO Gypsum Product Information	12

UNDERSTANDING ACOUSTICS

Sound 101	19
Noise Control in Buildings	21
The Risks of Flanking	23
Preventing Sound Leaks	25
Absorption, Reflection & Transmission	26
Sound Transmission Class (STC)	27
Contemporary Testing	28
Navigating Test Reports	29
Sound Intensity	30
Key Factors that Contribute to STC	31
The Impact of Steel Stud Selection	32
Speech Privacy Class	33
How QuietRock Works (CLD)	34

ACOUSTIC & FIRE RATED ASSEMBLIES

Old Design Conversion Table	36
Fire-Rated Designs Cross-Reference	38
New Designs	41
Steel Frame, Single	43
15 mil	44
18 mil	50
19 mil	55
33 mil	61
43 mil	73
54 mil	80
68 mil	93
97 mil	99
Steel Frame, Staggered	105
Steel Frame, Double	109
Wood Frame, Single	125
Wood Frame, Staggered	145
Wood Frame, Double	149
Area Separation Walls	153

APPENDIX

Horizontal vs. Vertical vs. Railroaded Installation	157
Alternate Fasteners	158
Fire Protection	159
Glossary	162
Legal Notices & Warranty information	166



About PABCO® Gypsum

For 50 years, PABCO Gypsum has been providing top quality gypsum panel products throughout North America. Family owned and operated from the very beginning, PABCO is committed to building a culture of caring. We do this by treating customers, employees and suppliers like family, developing relationships based on mutual trust and respect, hiring and training the best people for the job.

Its origins date back to 1953 when Fred Anderson opened the doors to Anderson Lumber Company in Sacramento, California. From those humble beginnings, Pacific Coast Building Products, Inc. was born. Through the years that followed Fred, and later, Dave Lucchetti, the company's president, purchased and founded building product-related businesses. In 2021, Ryan Lucchetti was appointed President and CEO of Pacific Coast Building Products, continuing its nearly 70 years of family leadership.

**"We run the company like a family.
Our business is built on relationships.
That is what distinguishes us from
our competition"**

David J. Lucchetti

Former President and Chief Executive Officer,
Pacific Coast Building Products, Inc.

PABCO Gypsum-Open for Business

PABCO Gypsum began operating in 1972 with the acquisition of an idle wallboard plant in Newark, California. Five years later, PABCO expanded its gypsum manufacturing capabilities with the acquisition of a gypsum plant and quarry north of Las Vegas, Nevada. Both plants have been expanded and modernized and now supply over 1.65 billion square feet of gypsum board annually.

The Las Vegas manufacturing and mining operation is the cornerstone of PABCO's dedication to quality, which begins literally from the ground up. Due to the unique placement of our gypsum deposits, PABCO was able to re-engineer the method of extracting the ore from the ground and load it directly into our wallboard manufacturing facility. Our ore is extracted, processed, refined and turned into gypsum panels all within our 4,200-acre footprint under the watchful eyes of some of the most tenured gypsum professionals in the country.

As a family concerned with the future, PABCO Gypsum adopted practices throughout its operations to minimize its impact on our environment. This is achieved by reducing and reusing waste, managing water consumption and using alternative energy in its production facility. To ensure finishing quality and consistency, the face and backing paper is manufactured within the family by PABCO® Paper, located in Vernon, California. Using 100% recycled content paper, PABCO Paper manufactures the gypsum liners for PABCO Gypsum and also produces liner board for corrugated boxes and chip paper grades.

QuietRock Added to PABCO Portfolio

The acquisitions continued with the purchase of QuietRock® in 2013, which brought the industry's first sound reducing drywall panel into the PABCO family. With manufacturing located in Newark, California, adjacent to PABCO's existing wallboard plant, the QuietRock product line is a natural complement to the 50-year history of the PABCO Gypsum product line.

Since QuietRock's origination in 2002, it has earned over 40 U.S. and foreign patents and patent applications. QuietRock achieves high sound attenuation and fire-resistance in one panel using less space, less material and less labor than conventional alternatives. Its advanced development team and a broad network of distributors and contractors throughout the U.S. and Canada contribute to thousands of QuietRock projects across North America.

The PABCO Promise

PABCO Gypsum's experienced sales and technical services teams are ready to assist you in the selection of gypsum products and solutions for you and your customers. Recognized by our customers as being easy to work with, our focus is making one part of the construction process easier for you. When you work with PABCO, you can expect consistently high-quality drywall, personal high-touch service and reliable technical advice from leading experts in the field.

PABCO Gypsum

Expert advice, service and drywall performance you can count on — what the job demands.

Guide Overview & General Notes

ORGANIZATION OF GUIDE

The systems in this Guide are organized by stud type and mil thickness according to the general categories below. A more detailed list can be found in the Table of Contents.

Steel Framing – Single
Steel Framing – Staggered
Steel Framing – Double
Wood Framing – Single
Wood Framing – Staggered
Wood Framing – Double
Area Separation Walls

The systems are arranged in descending order by STC rating within each stud type category. If there are tested assemblies at 16" o.c. and 24" o.c. they will be displayed side-by-side for easy comparison.

The STC listed is the reported value provided by the independent testing lab and report number indicated for the assembly. Any misleading conclusions that can arise from displaying STC values as a range have been eliminated.

PABCO Gypsum Design Number – The PABCO Gypsum Design Number has been revised to offer you the following benefits:

- Provides more insight into the design,
- Enables designs contained in this Guide to be listed in numerical order, making it easier to find the design you need,
- Reflects the new addition to the Guide showing side-by-side comparisons of 16" oc and 24" oc on the same assembly

Explanation of PABCO Gypsum Design Number

1. PGD=PABCO Gypsum Design. This will help identify the source of the design and eliminate confusion with other handbooks and guides.
2. Construction Type if other than a Wall Partition (for example an Area Separation Wall would be ASW)
3. Stud Type
 - a. Wood=W
 - b. Steel=Noted by mil thickness
4. Stud Width
 - a. Wood=If other than standard width of 4"
 - b. Steel=If other than standard width of 3-5/8"
5. Stud Configuration (if other than single)
 - a. S=Staggered
 - b. D=Double
6. Assembly Number within the Category (the lower the number, the higher the STC value)
7. Stud Spacing
 - a. 16" o.c.=16
 - b. 24" o.c.=24

Examples:

PGD-336-123-24

PABCO Gypsum Design wall partition, 33 mil steel stud, 6" wide, single configuration, assembly #123, 24" o.c.

PGD-WS-234-16

PABCO Gypsum Design wall partition, wood, staggered configuration, assembly #234, 16" o.c.

For cross reference purposes, the **PABCO® Sound Designs** include the GA File Number, UL/ULC Design Number or other Fire Test Report information where applicable.

All PABCO Gypsum Designs (PGD) contain a brief yet detailed description of the components used as the assembly was built for sound testing purposes. In instances where the sound assembly configuration differs from the fire test or is outside of the min max ranges of spacing, those differences are noted. Most differences relate to screw length and spacing. You will not find differences related to added materials or alternate configurations that do not conform to the requirements of the fire rated design indicated.

Each detailed description is accompanied by a cross-section detail of the system. The descriptions are listed in the order of material as one looks at the drawings from top to bottom.

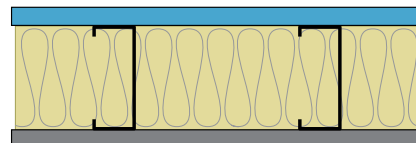

Unless indicated otherwise, all load-bearing wood stud systems were tested while being subjected to the maximum load allowed by design under nationally recognized design criteria at the time of the test. Due to an increase in the maximum allowable loading in the National Design Specifications (1982 and later editions), the American Forest and Paper Association issued the following statement: Where a load-bearing fire rated wood stud wall assembly contained in this Guide is specifically designed for structural capacity, the design value in compression parallel to grain adjusted for slenderness ratio (F_c') used in such analysis shall be taken as 78 percent of the maximum F_c' value determined in accordance with normal design practice but shall not exceed 78 percent of the F_c' value for such member having a slenderness ratio (l_e/d) of 33.

Unless otherwise stated in the listing, all wood framed wall systems in this Guide were tested using studs of nominal 2x4 or 2x6 dimension lumber. For information on the use of engineered wood wall framing, consult the supplier of the engineered wood product.



Note: Listing of a system in a specific category in this Guide is not intended to limit its use to that category (see General Explanatory Note 14 on page 9). However, this shall not be interpreted to imply that vertical systems, such as walls and partitions, are permitted to arbitrarily be used in a horizontal orientation. Contact PABCO Gypsum Technical Services for other products which satisfy the fire and sound requirements shown for the systems.

DESCRIPTION OF TERMS AND SYMBOLS USED IN THIS GUIDE

Gypsum Panel Products - defined in ASTM C11 *Standard Terminology Relating to Gypsum and Related Building Materials and Systems*, as “the general name for a family of sheet products consisting essentially of gypsum.”

Note: This term includes gypsum board, glass mat gypsum panels, fiber reinforced gypsum panels, and factory laminated gypsum panels.

Gypsum board may be further described as follows:

- **Regular Gypsum Board** - a gypsum board with naturally occurring fire resistance from the gypsum in the core; or
- **Type X Gypsum Board** - a gypsum board with special core additives to increase the natural fire resistance of regular gypsum board.

GENERAL EXPLANATORY NOTES

1. All dimensions, weights, temperatures, and pressures are in U.S. customary units. For commonly used metric (SI) conversions refer to the Appendix and IEEE/ASTM S10-2002, Standard for Use of the International System of Units (SI): The Modernized Metric System.
2. Nails shall comply with ASTM F547 or ASTM C514. Other nails, suitable for the intended use, and having dimensions not less than those specified in this Guide shall be permitted as substitutions.
3. Fasteners installed along the edges of gypsum board shall be placed along the paper bound edges on the long dimension of the board. Fasteners at the end shall be placed along mill or field cut ends on the short dimension. Fasteners on the perimeter of the board shall be placed along both edges and ends. Indicated fastener spacings are maximums. Closer fastener spacing may reduce the STC.
4. Screws meeting ASTM C1002 shall be permitted to be substituted for the prescribed nails, one for one, when the length and head diameter of the screws equal or exceed those of the nails specified in the tested system and the screw spacing does not exceed the spacing specified for the nails in the tested system.
5. Vertically applied gypsum board shall have the edges parallel to framing members. Horizontally applied gypsum board shall have the edges at right angles to the framing members. Intermediate vertical framing members are those between the vertical edges or ends of the board. Board orientation may not affect the STC.
6. Unless otherwise specified, the face layers of all systems, except exterior gypsum sheathing panels, shall have joints taped with either paper tape or glass fiber mesh tape (minimum Level 1 as specified in GA-214, Recommended Levels of Gypsum Board Finish) and fastener heads treated. Base layers in multi-layer systems shall not be required to have joints or fasteners taped or covered with joint compound.
7. Unless otherwise stated in the detailed description of the individual system, joints shall be staggered as follows:
 - a. Horizontal butt joints on opposite sides of a partition in single-layer applications shall be staggered not less than 12 inches.
 - b. Horizontal butt joints in adjacent layers on the same side of a partition in multi-layer applications shall be staggered not less than 12 inches.
 - c. Vertical joints on opposite sides of a partition in single layer applications shall not occur on the same stud.
8. When a fire-resistance rated partition extends above the ceiling, the gypsum board joints occurring above the ceiling need not be taped and fasteners need not be covered when all of the following conditions are met.
 - a. The ceiling is part of a fire-resistance rated floor-ceiling or roof-ceiling system;
 - b. All vertical joints occur over framing members;
 - c. Horizontal joints are either staggered 24 inches o.c. on opposite sides of the partition, or are covered with strips of gypsum board not less than 6 inches wide; or the partition is a two-layer system with joints staggered 16 inches or 24 inches o.c.; and
 - d. The partition is not part of a smoke or sound control system. Where joint treatment is discontinued at or just above the ceiling line, the vertical joint shall be cross taped at this location to reduce the possibility of joint cracking.
9. Metallic outlet boxes shall be permitted to be installed in wood and steel stud walls or partitions having gypsum board facings and classified as two hours or less. The surface area of individual boxes shall not exceed 16 square inches. The aggregate surface area of the boxes shall not exceed 100 square inches in any 100 square feet. Boxes located on opposite sides of walls or partitions shall be in separate stud cavities and shall be separated by a minimum horizontal distance of 24 inches. Approved nonmetallic outlet boxes shall be permitted as allowed by local code. Installing outlet boxes in sound control systems may reduce the STC. Outlet boxes installed in sound controlled systems should be treated with an acoustical putty such as QuietPutty® to mitigate flanking paths.
10. Water-resistant gypsum backing board shall be installed over or as part of the fire-resistance rated system in areas to receive ceramic or plastic wall tile or plastic finished wall panels. When fire or sound ratings are necessary, the gypsum board required for the rating shall extend down to the floor behind fixtures so that the construction will equal that of the tested system.

Note: The use of water-resistant gypsum backing board as a base for tile in wet areas is regulated by local codes. Consult local building codes for requirements.



11. When not specified as a component of a fire tested wall or partition system, either faced or unfaced mineral fiber, glass fiber, or cellulose fiber insulation of a thickness not exceeding that of the cavity depth shall be permitted to be added within the stud cavity. Adding insulation may improve the STC.
12. In each system containing batt or blanket insulation the insulation is specified to be either mineral or glass fiber and, for fire resistance, the system shall be built using the type specified. Insulation shall be permitted to be either faced or unfaced.
13. A vapor retarder shall be permitted to be added to any fire-resistance rated system.
14. Although the systems are arranged in general groupings (i.e. walls and interior partitions, floor- ceilings, roof-ceilings, etc.), this is not intended to limit their use only to the specific category in which they are listed. For example, systems listed as shaft walls shall be permitted to be used as interior partitions. However, systems tested vertically (walls and partitions) shall not be permitted to be arbitrarily used in a horizontal orientation.
15. Unless otherwise specified in the detailed description, the generic steel studs and runners used in nonload-bearing walls and partitions in this Guide were fabricated from flat steel having a bare metal thickness of not less than 0.0179 inch and have a return lip dimension of not less than 3/16 inch.

Note: Consult the steel stud manufacturer for performance data and recommendations before substituting proprietary steel studs that either are fabricated from steel having a bare metal thickness of less than 0.0179 inch or have a return lip dimension less than 3/16 inch.

16. Greater stud sizes (depths) shall be permitted to be used in metal- or wood-stud systems. Metal studs of heavier gage than those tested shall be permitted. The assigned rating of any load-bearing system shall also apply to the same system when used as a nonload-bearing system. Indicated stud spacings are maximums. Heavier gage studs or closer stud spacing may reduce the STC. Greater stud depth may improve the STC.
17. Within design limitations, the distance between parallel rows of studs, such as in a chase wall, shall be permitted to be increased beyond that tested. When stud cavities in walls constructed of parallel rows of steel studs exceed 9-1/2 inches and cross bracing is required the cross bracing shall be fabricated from steel studs. Greater wall depth may improve the STC.
18. Systems tested with metal furring channels attached directly to the bottom chords of steel beams, bar joists, or wood trusses or framing shall be permitted to be suspended. Generally, furring channels are attached to 1-1/2 inch cold rolled carrying channels 48 inches o.c. suspended from joists by 8 ga wire hangers spaced not greater than 48 inches o.c.
19. Where laminating compound is specified, taping, all-purpose, and setting type joint compounds shall be permitted.
20. Additional layers of type X or regular gypsum panels shall be permitted to be added to any system. Additional layers of gypsum board may improve the STC.

21. When not specified as a component of a fire- resistance rated wall or partition system, cementitious backer units and/or wood structural panels shall be permitted to be added to one or both sides. Such panels shall be permitted to be applied either as a base layer directly to the framing (under the gypsum board), as a face layer (over the face layer of gypsum board), or between layers of gypsum board in multi-layer systems. Where such panels are applied under the gypsum board or between layers of gypsum board the length of the fasteners specified for the attachment of the gypsum board applied over the panels shall be increased by not less than the thickness of the panels. Fastener spacing for the gypsum board and the number of layers of gypsum board shall be as specified in the system description.
22. When additional panels, such as those noted in 20 and 21 above, are applied, and joints are staggered from previous layer, joints are not required to be finished.
23. Each system in this Guide lists specific products that are acceptable for use in the specific system in which they are listed. Consult PABCO® Gypsum Technical Services for information on products suitable for use in specific proprietary systems.

TESTING AGENCIES

Each detailed description is accompanied by a cross- section detail of the system. Also included is design information giving total thickness, limiting height where appropriate, and approximate weight of the system in pounds per square foot. Fire and sound test references identifying the agency which certified the test as well as a report number and date are also provided (see Tables I and II).

TABLE I - FIRE TESTING AGENCIES

UL	Underwriters Laboratories Inc.
ULC	Underwriters' Laboratories of Canada
WFCi	Western Fire Center, Inc.

TABLE II - SOUND TESTING AGENCIES

NOAL	North Orbit Acoustical Laboratories
NRCC	National Research Council of Canada
OL	Orfield Laboratories, Inc.
RAL	Riverbank Acoustical Laboratories

PRODUCT IDENTIFICATION

All gypsum products are identified by the PABCO Gypsum product name and trademark, if applicable. The thickness and type of gypsum board are shown on the end bundling tape or on the board. Ready-mixed joint compounds are identified on the container. Bagged products are identified on the bag. ASTM standard product specifications are shown in Table III.



TABLE III - APPLICABLE ASTM PRODUCT STANDARDS

Product	ASTM Standard
Gypsum Board	C1396*
Gypsum Wallboard	C1396, Sec. 5*
Predecorated Gypsum Board	C1396, Sec. 5*
Gypsum Lath	C1396, Sec. 11*
Gypsum Sheathing Board	C1396, Sec. 9*
Gypsum Backing Board	C1396, Sec. 6*
Gypsum Coreboard	C1396, Sec. 6*
Gypsum Shaftliner Board	C1396, Sec. 6*
Water-Resistant Gypsum Backing Board	C1396, Sec. 7*
Gypsum Ceiling Board	C1396, Sec. 12*
Exterior Gypsum Soffit Board	C1396, Sec. 8*
Gypsum Base for Veneer Plasters	C1396, Sec. 10*
Glass Mat Gypsum Panels	C1658
Glass Mat Gypsum Substrate for Use as Sheathing	C1177
Glass Mat Water-Resistant Gypsum Backing Panel	C1178
Fiber Reinforced Gypsum Panels	C1278
Abuse-Resistant Non-decorated Interior Gypsum Panel Products	C1629
Factory-Laminated Gypsum Panel Products	C1766
Joint Compound	C475
Gypsum Plasters	C28
Gypsum Veneer Plaster	C587
Metal Lath	C847
Accessories for Gypsum Wallboard and Gypsum Veneer Base	C1047
Nails for the Application of Gypsum Board	C514
Steel Drill Screws for the Application of Gypsum Panel Products or Metal Plaster Bases (Types G, W, and S)	C1002
Steel Drill Screws for the Application of Gypsum Panel Products or Metal Plaster Bases to Steel Studs from 0.033 in. (0.84 mm) to 0.112 in. (2.84 mm) in Thickness (Type S-12)	C954
Nonstructural Steel Framing Members	C645
Load-Bearing (Transverse and Axial) Steel Studs, Runners (Tracks), and Bracing or Bridging for Screw Application of Gypsum Panel Products and Metal Plaster Bases	C955
* ASTM Specification C1396 is a consolidation of previous ASTM Standards C36, C37, C79, C442, C588, C630, C931, C960, and C1395, which have been withdrawn.	

ABBREVIATIONS

Abbreviations used in this Guide are shown in Table IV (also see Tables I and II on page 11).

TABLE IV - ABBREVIATIONS

C&P	carpet and pad
dB	decibel
dia	diameter
est	estimated
FSTC	Field Sound Transmission Class
FSTL	Field Sound Transmission Loss
ft	foot
ga	gage or gauge
galv	galvanized
Hz	hertz (cycles/second)
hr	hour
IIC	Impact Insulation Classification
in.	inch
lab	laboratory
lb	pound
mfr	manufacturer
mm	millimeter
min	minimum
nom	nominal
NLB	nonload-bearing
o.c.	on center
oz	ounce
pcf	pounds per cubic foot
psf	pounds per square foot
rev	revised
RC	Resilient Channel
sq	square
STC	Sound Transmission Class
STL	Sound Transmission Loss
T&G	tongue and groove



METRIC CONVERSIONS

TABLE V - METRIC CONVERSIONS		
	STANDARD	METRIC
Gypsum Panel Thickness	1/4 inch	6.4 mm
	3/8 inch	9.5 mm
	1/2 inch	12.7 mm
	5/8 inch	15.9 mm
	3/4 inch	19.0 mm
	1 inch	25.4 mm
Frame Spacing	8 inch	203 mm
	12 inch	305 mm
	16 inch	406 mm
	24 inch	610 mm
Fastener Spacing	2 inch	51 mm
	2-1/2 inch	64 mm
	7 inch	178 mm
	8 inch	203 mm
	12 inch	305 mm
	16 inch	406 mm
	24 inch	610 mm
Temperature	40°F	5°C
	50°F	10°C
	125°F	52°C

STEEL STUD REFERENCE

All steel studs listed in the PABCO Gypsum Designs are shown by mil thickness. Below is a reference table showing the equivalent gauge and thickness range for each mil thickness.

TABLE VI - STEEL STUD THICKNESS / GAUGE REFERENCE			
MIL THICKNESS	THICKNESS RANGE	GAUGE	DESIGNATION
15 mil	.0147" - .0155"	25	Equivalent
18 mil	.0179"		Drywall
19 mil	.0190" - .0200"	20	Equivalent
30 mil	.0235" - .0312"		Drywall
33 mil	.0223"-.0346"		Structural
43 mil	.0380"-.0428"	18	
54 mil	.5380"	16	
68 mil	.0678"	14	
97 mil	.0960"	12	



Go Ahead, Turn Up the Sound of Silence

We make it easy!

Whether you're building a hospital, hotel, high-end recording studio or multi-family project, you need outstanding acoustic performance that's cost effective. QuietRock® is the original, most technically advanced sound reducing drywall that architects trust and installers swear by. Backed by industry leading service and support that's music to your ears.

- ✓ **unmatched performance**
- ✓ **fire/sound design expertise**
- ✓ **helpful technical support**
- ✓ **reliable test data**
- ✓ **useful tools and resources**

It's easy! Call or visit us online to learn more.

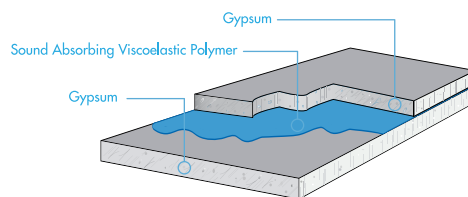

Patented "thin wall technologies" improve Sound Transmission Class (STC) performance while using less material and reducing installation time.





STANDARD INTERIOR

PABCO® REGULAR

PABCO Regular Gypsum Board is an interior panel composed of a naturally noncombustible, dimensionally stable, gypsum core. The core is wrapped in 100% recycled facing and backing paper that will accept most decorative finishes. Regular Gypsum Wallboard is intended for non-fire rated residential construction.

Thickness	Type	UL Core
1/4"	Regular	N/A
3/8"	Regular	N/A
1/2"	Regular	N/A

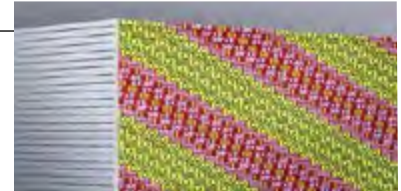

PABCO FLAME CURB®

PABCO FLAME CURB gypsum panels are composed of a naturally combustible, fire-resistant gypsum core reinforced with glass fibers that provide increased strength and enhanced fire-resistant properties. The core is wrapped in 100% recycled facing and backing paper that will accept most decorative finishes. FLAME CURB is intended for fire-rated interior walls and ceilings in residential and commercial construction.

Thickness	Type	UL Core
1/2"	Super C	PC-C
5/8"	Type X	PG-11
5/8"	Type C	Type C
3/4"	Type X	PG-13

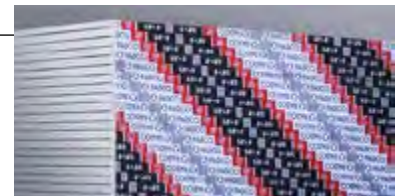

PABCO MOLD CURB® Plus

MOLD CURB Plus is a mold and water-resistant gypsum panel that can be used for walls and ceilings where increased resistance to moisture is needed. The core is wrapped in 100% recycled facing and backing paper that is treated with mold and water-resistant agents to inhibit the growth of mold and mildew. Mold Resistance is rated at 10, the highest rating (ASTM D3273).

Thickness	Type	UL Core
1/2"	Regular	N/A
5/8"	Type X	PG-5W



PABCO LITECORE®

PABCO LITECORE is a lightweight, dual purpose drywall product for use on walls and ceilings. It is dimensionally stable and resists sagging, buckling and warping. The panel features a naturally noncombustible gypsum core and 100% recycled facing and backing paper that will accept most decorative finishes. It is intended for use on non-structural, non-fire-rated applications.

Thickness	Type	UL Core
1/2"	LiteCore	N/A



PABCO® FLEX

PABCO Flex gypsum panels are ideal for concave and convex surfaces in non-structural walls and ceilings. The unique thickness of PABCO Flex allows you to create a curved wall with a single layer application and feather the finish into an adjoining flat wall surface. The product is naturally noncombustible with a gypsum core wrapped in 100% recycled facing and backing paper that will accept most decorative finishes. PABCO Flex is intended for interior, non-fire rated residential construction.

Thickness	Type	UL Core
3/8"	FLEX	N/A

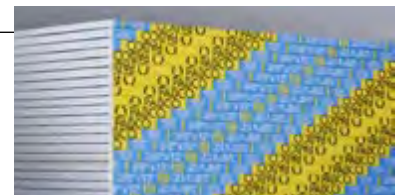



IMPACT AND ABUSE PROTECTION

PABCO ABUSE CURB®

PABCO ABUSE CURB is a Type X gypsum panel comprised of a proprietary high-density, fire-resistant gypsum core that incorporates the MOLD CURB Plus technology. It is designed for use in high traffic areas such as corridors in schools, hospitals and offices where surface abrasion, indentation, mold and water-resistance are needed. The core is encased in 100% recycled heavy mold and water-resistant paper facing and backing.

Thickness	Type	UL Core
5/8"	Type X	PG-5W

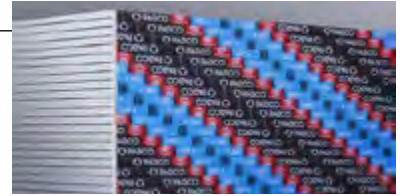

PABCO® IMPACT RESISTANT

PABCO Impact Resistant drywall is a true super panel: Type X fire resistant, mold and water resistant, abrasion and impact resistant. The product is manufactured with a proprietary high density, fire resistant Type X core that incorporates an embedded fiberglass mesh to further enhance impact resistance.

Thickness	Type	UL Core
5/8"	Type X	PG-5W

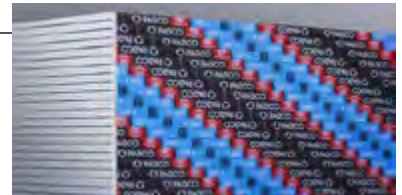

CEILING APPLICATIONS

PABCO® INTERIOR CEILING

PABCO Interior Ceiling board is a sag resistant gypsum ceiling panel designed for non-fire rated interior ceiling applications. The ceiling panel is manufactured with a dimensionally stable, noncombustible gypsum core that is formulated to significantly reduce ceiling sag. PABCO Interior Ceiling board shows superior sag resistance when tested to ASTM 473 for humidified deflection. Can be installed perpendicular or parallel to framing at 24" on center per ICC-AC417.

Thickness	Type	UL Core
1/2"	Regular	N/A



PABCO SOUND CURB™

SOUND CURB gypsum panels are ideal for floor/ceiling applications in multifamily residential and commercial projects. The 3/4" panels are comprised of a proprietary high-density Type X gypsum core and are perfect where fire resistance is a primary objective and additional mass is needed for improved Sound Transmission Class (STC) and Impact Insulation Class (IIC) performance. They also work well for lower frequencies where sound control has proven difficult.

Thickness	Type	UL Core
3/4"	Type X	PG-13



EXTERIOR APPLICATIONS

PABCO® GYPSUM SHEATHING

PABCO GYPSUM Sheathing is an economical moisture-resistant product and is designed for use as an exterior board providing a stable base for veneer finishing systems on residential and commercial buildings. The board is comprised of a water-resistant core and water-repellent paper.

Thickness	Type	UL Core
5/8"	Type X	PG-5WS



PABCO® EXTERIOR SOFFIT

PABCO Exterior Soffit is designed for application on the underside of exterior soffits, open porches, walkways, carport ceilings and similar installations that are completely protected from contact with water. The gypsum core contains additives that enhance its ability to resist sagging and is wrapped in a moisture resistant paper to increase its resistance to moisture.

Thickness	Type	UL Core
1/2"	Regular	N/A
1/2"	Super C	PG-C
5/8"	Type X	PG-11
5/8"	Type C	Type C

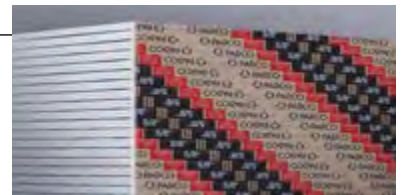



SHAFTLINERS

PABCO GLASS® SHAFTLINER

PABCO GLASS Shaftliner panels protect your buildings from fire, mold and water. They are ideal for lining elevator shafts, stairwells and constructing light weight fire barriers for cavity shaft walls and area separation walls in commercial and multi-family residential applications. The proprietary gypsum core is reinforced with glass fibers to increase stability. The product is encased in our distinctive orange, mold resistant coated fiberglass mat facing that resists warping, rippling, buckling and sagging.

Thickness	Type	UL Core
1"	Type X	PG-10



PABCORE® SHAFTLINER

PABCORE Shaftliner Type X panels are manufactured with a proprietary fire-resistant Type X core which has been reinforced with glass fibers and other additives to increase its fire resistance. The core is encased in 100% recycled paper that is treated with mold and water-resistant agents to inhibit the growth of mold and mildew.

Thickness	Type	UL Core
1"	Type X	PG-10



GLASS MAT

PABCO GLASS® SHEATHING

Easily identified by its orange colored mat face, PABCO GLASS Sheathing is ideal for exterior commercial and residential applications subject to extended exposure during construction. The product can withstand extended exposure to normal weather conditions up to 1 year. It is comprised of a proprietary formula that provides a fire-resistant, mold- and water-resistant gypsum core that has been reinforced with glass fibers to increase stability.

Thickness	Type	UL Core
1/2"	Regular	N/A
5/8"	Type X	PGS-WRS



PABCO GLASS® INTERIOR

PABCO GLASS Interior, with its mold and water-resistant gypsum core encased in a glass fiber mat, offers greater moisture resistance and improved dimensional stability compared to standard gypsum board. The product scores 10 for mold resistance, the highest rating when tested in accordance to ASTM D3273 *Standard Test Method for Resistance to Growth of Mold on the Surface of Interior Coatings in an Environmental Chamber. The product is specially formulated to withstand extended exposure under normal weather conditions up to one year, making it ideal for pre-rock construction. The interior glass-faced panel is noncombustible, dimensionally stable and resists warping, sagging and buckling.

Thickness	Type	UL Core
1/2"	Regular	N/A
5/8"	Type X	PGI

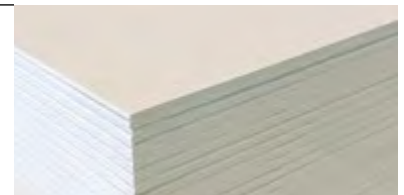



SOUND REDUCING DRYWALL

QuietRock® ES

QuietRock ES is the first sound reducing drywall that easily scores and snaps using breakthrough EZ-SNAP™ technology. The patented QuietRock ES has no paper or metal on the inside of the panel making installation a snap. QuietRock ES cuts and installs like standard drywall while delivering acoustical ratings of up to STC 55 on single stud construction. It is ideal for residential and commercial construction with a lower total installed cost than other noise control methods, such as resilient channel and multi-layer drywall.

Thickness	Type	UL Core
5/8"	Type X	QRES



QuietRock® ES MR

QuietRock ES Mold Resistant is the first and only easy score and snap, mold resistant sound damping drywall available. QuietRock ES Mold Resistant delivers reliable acoustic performance at a low installed cost - saving time, labor, materials, and valuable floor space. The mold resistant treatment to the paper and core can contribute to a healthier indoor environment. QuietRock ES Mold Resistant achieves the maximum score of 10 on the ASTM 3273 mold test, making it ideal for hospitals, schools, government projects and other mold sensitive applications.

Thickness	Type	UL Core
5/8"	Type X	QRES



QuietRock® 510

QuietRock 510 is designed to improve Sound Transmission Class (STC) performance at an entry level price. QuietRock 510 is an excellent choice for boosting STC ratings for residential remodeling and new construction projects where a 1/2" panel thickness is desired. QuietRock 510 installs and finishes like standard drywall, requiring no special tools or training to use.

Thickness	Type	UL Core
1/2"	N/A	QR510



QuietRock® 530

QuietRock 530 is a versatile, high performance gypsum panel that delivers superb noise reduction. This 'super panel' is UL fire-rated, STC-rated, shear-rated, and impact-resistant.

Thickness	Type	UL Core
5/8"	N/A	QR530



QuietRock® 545

QuietRock 545 is the only sound damping panel that is designed for maximum sound isolation across a broad frequency range. QuietRock 545 is ideal for high-end home theaters, commercial theaters, professional studios, music rooms, and other projects where low-frequency mitigation is critical.

Thickness	Type	UL Core
1-3/8"	N/A	QR545





QUIET® SYSTEM ACCESSORIES AND COATINGS

QuietSeal® Pro

QuietSeal Pro is a high performing, non-hardening acoustical sealant used to maintain optimum acoustic performance of your wall assembly. Apply it around perimeters of the walls to prevent noise leaks. QuietSeal Pro stays soft over time to prevent cracking while continuing to reduce sound transmission. It is easy to use and offers a hassle free clean up – just use soap and water.

Applied Thickness	Coverage	VOC
Approx. 1/4" bead	88 Linear feet using a 1/4" bead	Low VOC <0.1 g/L



QuietPutty®

QuietPutty is Class-A fire-resistant acoustical putty designed to preserve the performance of STC rated assemblies. Use QuietPutty on electrical outlet boxes, rocker switches, HVAC ducts, water hookups, cable systems or any other penetration that requires an acoustic seal. QuietPutty is clean, easy to use and requires no tools to apply. QuietPutty will not shrink and remains soft over time, ensuring a long-term seal that maximizes STC performance.

Size	Coverage
1/8" thick 7-1/4"x 7-1/4"	1 pad per 2"x4" junction box



QuietGlue® Pro

QuietGlue Pro is a high performance, low cost acoustical compound designed to be cost effective for commercial projects and small do-it-yourself projects. QuietGlue Pro can be applied to drywall or wood (plywood, OBS, MDF) to create a constrained layer damped lamination in the field. Ideal applications include subfloor laminations, curved walls, coffered ceilings or in situations where sourcing QuietRock may not be practical. QuietGlue Pro is not a construction adhesive. Laminated layers must be mechanically attached in accordance with local building requirements.

Applied Thickness	Coverage	VOC
1/8" bead random pattern	One 28 oz Tube per 4x8 sheet (32 ft²)	Low VOC <0.1 g/L



QuietCoat®

QuietCoat is a sprayable, viscoelastic polymer coating that reduces noise and vibration with minimum weight, bulk and cost. QuietCoat® is engineered specifically for coating nonporous materials including stainless steel, galvanized iron, aluminum and composite (reinforced plastic) materials.

Fully ROHS Compliant
Meets the highest industry flammability standards
Anti-fungal and anti-rust capability

Common uses include: plumbing and sewer pipes, consumer electronics, appliances, factory process and material handling equipment, HVAC, air handling units, ducts, elevators, escalators, vehicles, and rail cars.

Applied Thickness	Coverage	VOC
1 to 3 mm total	40-80 ft² per gallon	Low VOC <0.1 g/L





QUIET® RF SYSTEM

QuietRock® 530 RF

QuietRock 530RF is a versatile, high performance sound damping gypsum panel that delivers superb noise reduction, radio frequency shielding along with fire and impact resistance. This specialty panel is typically used in the construction of high security environments such as SCIF rooms, government offices and data centers where radio frequency disturbances can affect sensitive data and equipment.

Thickness	Type	UL Core
5/8"	N/A	QR530



QuietSeam® RF

QuietSeam RF is a conductive sealing and bedding compound used to maintain metal to metal and grounded connectivity on field-modified QuietRock® 530RF panels. Available in 1 gallon pails.

Applied Thickness	Coverage
3/8" bead	500 linear feet per gallon



Quiet® RF Shielding Tape

Quiet RF Shielding Tape is an electrically conductive tape used to maintain metal to metal connectivity at the joints and when QuietRock 530 RF panels are cut to size in the field. Available in 3/4" and 1-3/4" widths.

Width	Coverage
3/4"	54 linear feet per roll
1-3/4"	



Sound 101

The fundamentals of sound

HEARING

The human ear is magnificent. Hearing is one of the first senses that we develop—long before birth—and one of the last to leave us before we expire. Hearing and sound affect virtually every facet of our lives.

WHAT IS SOUND

Sound is best defined as an auditory form of energy. Unlike light (electromagnetic energy), the propagation of sound requires the existence of a medium such as air or water.

SOUND IS A WAVE

Small periodic changes in pressure reach our ears, resulting in audible sound. These sound waves radiate from all kinds of sound sources.

Sound waves have some essential characteristics that determine how they sound to us when they reach our ears. Storage boxes can come in different shapes, sizes, and colors that make them useful for organizing and storing. In a similar way, sound waves come in different frequencies (pitch), wavelengths (speed), and amplitudes (volume). Each characteristic changes how we perceive the sound we hear.

FREQUENCY & WAVELENGTH

If you are swimming in the ocean there is a big difference between the peaks of the waves when you are out in the open ocean versus when you are near the shore. Near the shore the wavelengths get smaller, causing you to float up and down faster. Sound waves behave similarly. When the wavelength of sound is shorter, the number of oscillations that occurs every second increases.

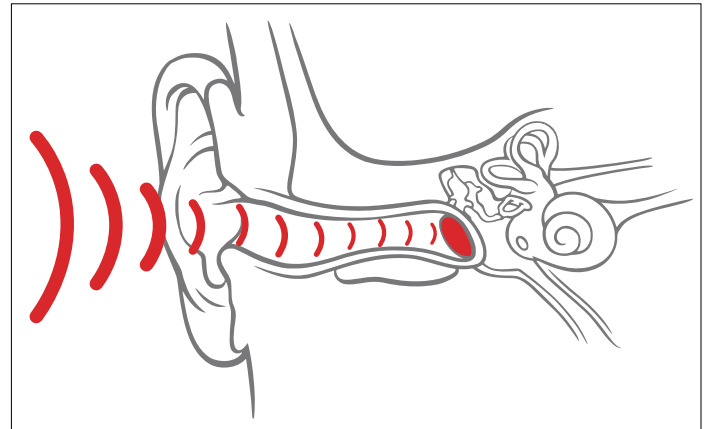
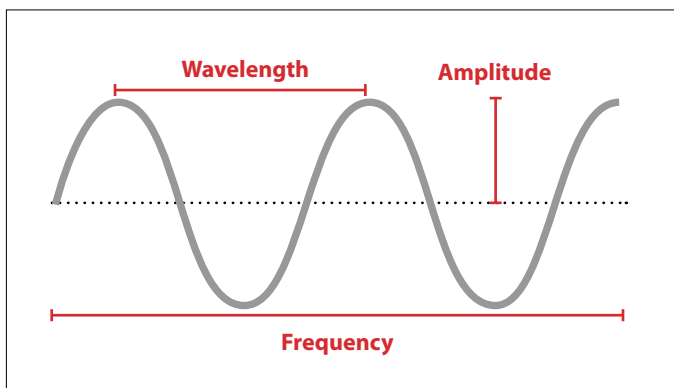

Frequency, measured in **Hertz (Hz)**, is the number of complete waves or oscillations at a point in time. Frequency is more commonly referred to as pitch. A high-speed dental drill has a higher frequency (shorter wavelength) than the passing of a dump truck down the street (longer wavelength). The audible range of frequencies for an average human is 20 Hz to 20,000 Hz.

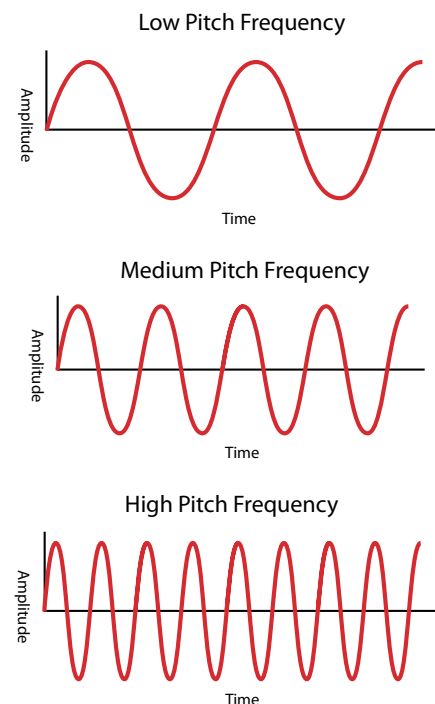



AMPLITUDE

The amplitude of a sound wave is closely related to how loud we perceive the sound to be. What makes loudness both complicated and amazing is that we perceive sound waves at different loudness levels for each frequency in the audible range. What's even more amazing is that most humans' ears are capable of hearing such an incredible dynamic range of loudness levels that both the faint movement of a mouse and the screaming rockets of a jet engine are well within our ability to hear.

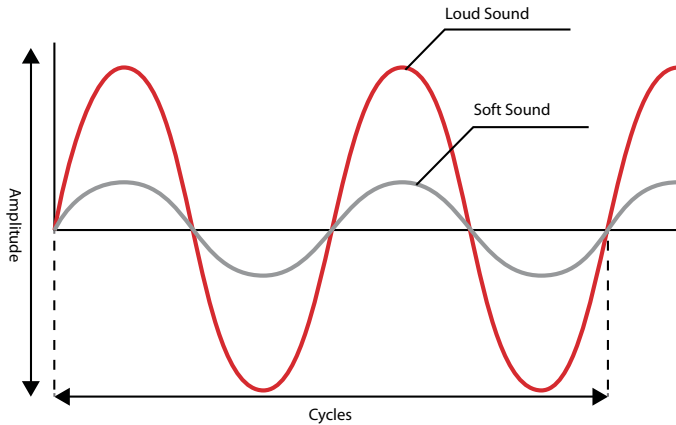

Although not directly related to loudness, sound is typically measured as a **sound pressure level (SPL)** in **decibels (dB)**. The general range of human hearing is from 0 to 120 dB. The sound of a quiet library is roughly 30 dB, while 120 dB is the threshold where the ears begin to feel pain because the sound is so loud.

THE DECIBEL IS NOT A LINEAR UNIT

Something important to remember about the decibel is that it is a non-linear (where $2 \text{ dB} + 2 \text{ dB}$ is NOT equal to 4 dB) unit of measurement.



Building materials such as **QuietRock® ES** can drastically affect the decibel level of sound that we hear through building partitions. The proper application of QuietRock®, for example, can help you lower the volume of your neighbors' loud argument to a faint muffle.



CURRENT BUILDING NOISE CONTROL TECHNIQUES

MASS: Adding mass, or layers of mass, is probably the most commonly used noise control technique.

Advantages:

1. The low frequency performance can improve with each additional layer or with increasing concrete slab thickness.
2. It is the most commonly tested building noise control treatment, which makes predictions more accurate and design recommendations easier to validate.
3. It is commonly used and familiar to the building trades.
4. It is simple. Just add another layer or install a thicker slab.

Disadvantages:

1. Both the labor and material costs keep escalating with each additional layer.
2. Construction delays are more common when more materials and labor are required.
3. As the stiffness of the assembly increases (heavier gauge studs are used or the spacing between studs is decreased), which commonly occurs, the effect of additional weight decreases. Light-gauge (thin) steel studs show differences with each additional layer, but not so with heavy-gauge steel studs.
4. The weight of the assembly increases drastically, which becomes a problem for buildings with stringent structural requirements.
5. Thick assemblies utilize expensive floorspace that can never be recovered without enlarging the footprint of the building.

AIR SPACE & FRAMING ISOLATION: Where possible, studs and stud frames can be separated (staggered or double studs) resulting in a wider air cavity between panels. Resilient channels can also be used that add air volume and attempt to mechanically separate or isolate the panels from the assembly framing.

Advantages:

1. Again, there is an increase in low frequency transmission loss (more noise control at those difficult low frequencies).
2. It is a commonly tested building noise control treatment.
3. The combination of decoupling the assembly elements and adding more air space can result in better noise control, versus many layers of mass.
4. There is more room for piping and other in-the-wall elements so they are easier to isolate from the rest of the structure.

Disadvantages:

1. Building these assemblies is much more complicated and involved: more materials are needed and labor costs increase dramatically.

2. There is much greater risk of failure, especially for the decoupling and isolating treatments such as resilient channels (RC) due to short-circuiting (see glossary term) or improper installation.
3. There is a reduction of usable floor space for these assemblies.

DAMPING: Internally damped panels can provide increased sound isolation to building partitions without increasing the weight and overall thickness.

Advantages:

1. It is a simple solution: just replace the standard panel on one or both sides with a damped panel of the same thickness/fire resistance/structural properties.
2. You can increase the floor space from that required by other methods.
1. Cost to install **QuietRock® ES** is equal to the installation of a standard sheet of drywall.
2. It is a better treatment for speech noise (privacy) than multiple layers of drywall.
3. With fewer materials required to achieve equivalent results, less time is needed and building construction remains on schedule.

Disadvantages:

1. The material cost for these premium panels is higher than less-expensive standard materials even if the less-expensive panels cannot achieve the same performance.
2. Standard damped panels perform similar to standard gypsum panels at low frequencies. Higher-performance damped panels, such as QuietRock 545, are required to provide better sound isolation for low frequency noise sources such as sub-woofers and turbines.

Rules of Thumb for Applying Acoustic Treatment in Buildings

Sound waves, like water, will find any leakage point through a partition. Since air offers less resistance to sound than a piece of metal or wood, much of the sound energy will exit a structure through air openings. There are other reasons why an acoustical design might fail, including acoustic "short-circuiting" (see glossary) failures and layout failures.

Here are some general recommendations for reducing the risk of failure for acoustic treatments:

1. Properly and adequately address penetrations (outlet boxes and recessed lights, for example) with **QuietSeal® Pro**, **QuietPutty®**, or other recommended treatments.
2. Avoid partial-height partitions (build partitions from floor to structural ceiling).
3. Take time to read and follow manufacturer recommendations for installation procedures (failures with RC are common when the RC is installed upside down or when partition surfaces rigidly touch adjacent surfaces).
4. Consult with an acoustician (acoustical consultant) for efficient floor plan layout (doors and noisy mechanical rooms) and air handling design.

Flanking

The indirect path to annoy your next door neighbor

TYPICAL FLANKING PATHS

Although you may have carefully thought out and specified the correct wall, unwanted sounds may still travel through undetected flanking paths such as framing, ductwork, concrete slabs, open plenums or wall penetrations.

HOW TO ADDRESS FLANKING

There are a few ways to address flanking. Here are some layout suggestions that can reduce some of the flanking issues:

1. Eliminate direct ducting by running a main line down a corridor or attic and auxiliary lines to each room. The more turns in the ducting, the more difficult it is for sound to find its way through it.
2. Avoid back-to-back penetrations by installing or relocating electrical and plumbing penetrations in separate stud cavities.
3. Continue the demising wall assembly up to the floor deck to prevent sound moving through the plenum space.
4. Decoupling the cement slab adjacent to the bottom wall plate may be necessary in sensitive situations.

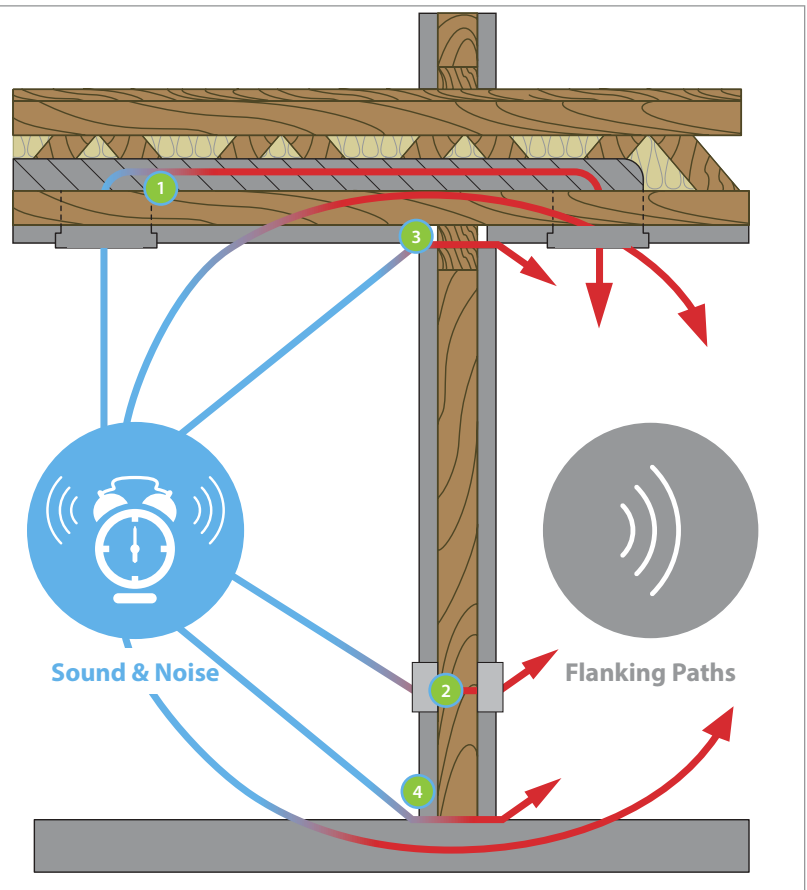
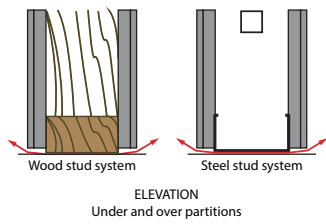

Figure 1: application of acoustic sealants prevent sound leaks and minimize the effects of flanking.

Flanking

SOUND ISOLATION CONSTRUCTION

"NORMAL" CONSTRUCTION
ARROWS SHOW
FLANKING PATHS



"SELECT" CONSTRUCTION
SEALING OF RELIEF DETAIL AT
PERIMETER OF PARTITION AND AROUND
CUT-OUTS TO PREVENT SOUND LEAKAGE

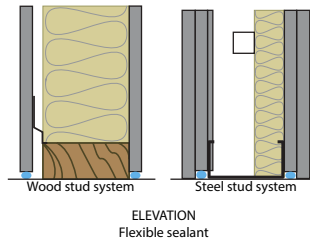

"PRE-DESIGN" CONSTRUCTION
SIMULATED LABORATORY
CONDITIONS

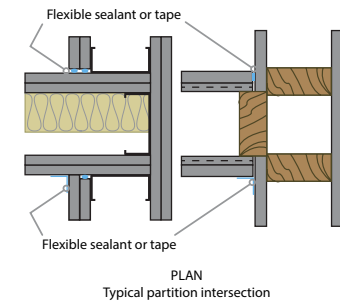
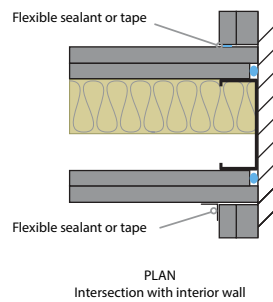
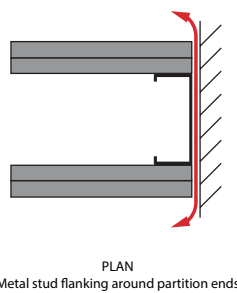
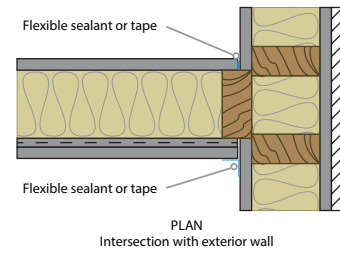
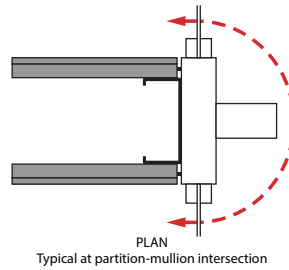
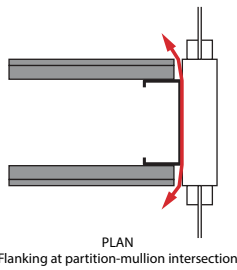
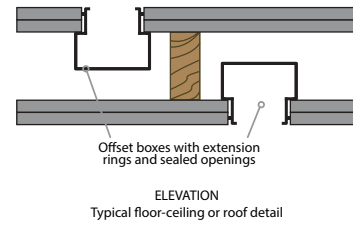
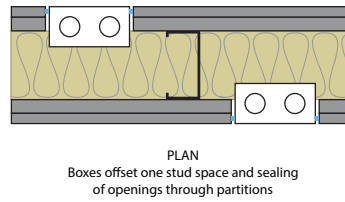
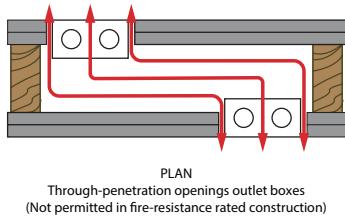
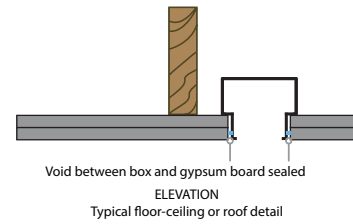
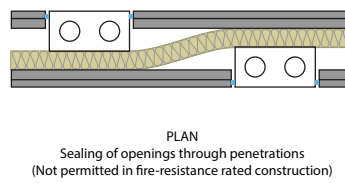
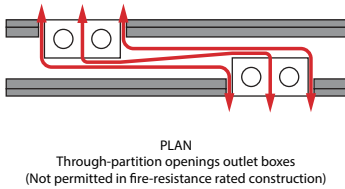
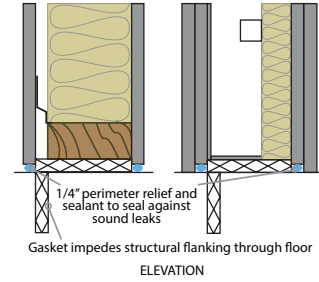

Flanking

PREVENTING SOUND LEAKS

Many flanking issues can be easily addressed by **properly sealing the wall and ceiling assemblies**. In any sound rated assembly it is good building practice to seal the gap at the base of the wall as well as expansion (control) and drywall-to-non-drywall (e.g. window mullion) joints with an acoustical sealant such as **QuietSeal® Pro**. QuietSeal® Pro will remain soft and pliable, a key factor in choosing a good **acoustic sealant**. QuietSeal® Pro contains very **low VOCs** (<0.1 g/L VOC).

Another tool in the fight against flanking is **QuietPutty®**, an **acoustical putty** typically molded around outlet boxes and plumbing fixtures to prevent sound from penetrating through the fixtures. QuietPutty® is **also fire rated** (ASTM E84 Flame Spread Index Class B) and out performs leading fire putties.

Untreated gaps can reduce the effectiveness of your well designed wall and ceiling systems. The use of QuietSeal® Pro and QuietPutty® will enable you to prevent leaks and achieve the best performance of your wall and ceiling systems.

WALL PENETRATIONS AND RECESSED LIGHTS

In terms of flow and resistance, **sound behaves similar to water**. It follows the path of least resistance, "searching" for any leaks in a given building assembly partition. Any untreated penetration can potentially decrease a partition's sound isolation.

The ASTM C919 Standard Practice for Use of Sealants in Acoustical Applications specifies that a non-hardening sealant, such as QuietSeal® Pro, must be applied to the partition to prevent sound leakage.

Larger penetrations such as outlet boxes and plumbing fixtures must be effectively plugged to prevent sound leakage. Acoustic putty, such as QuietPutty®, can be applied to create such a plug.

Recessed Lights create large open holes in the ceiling and are very difficult to treat. Effective treatment for recessed light penetrations involves building a sound isolation box with QuietRock® around the light opening inside the joist cavity.

Alternatively, a track lighting system could be used to avoid numerous penetrations that are more difficult to address.

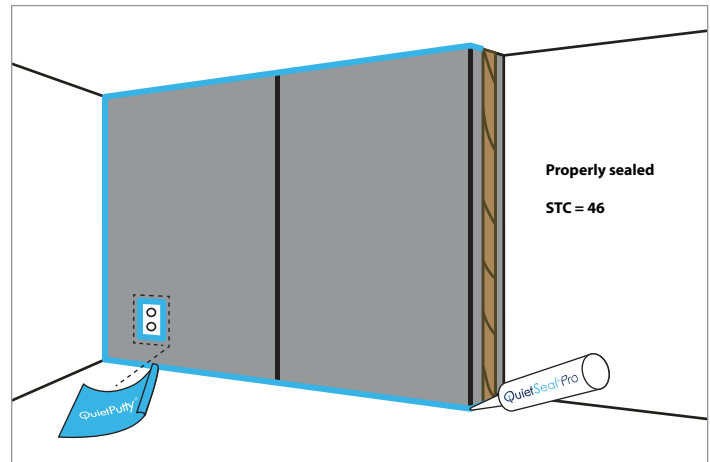

Figure 2: application of acoustic sealants prevent sound leaks and minimize the effects of flanking.

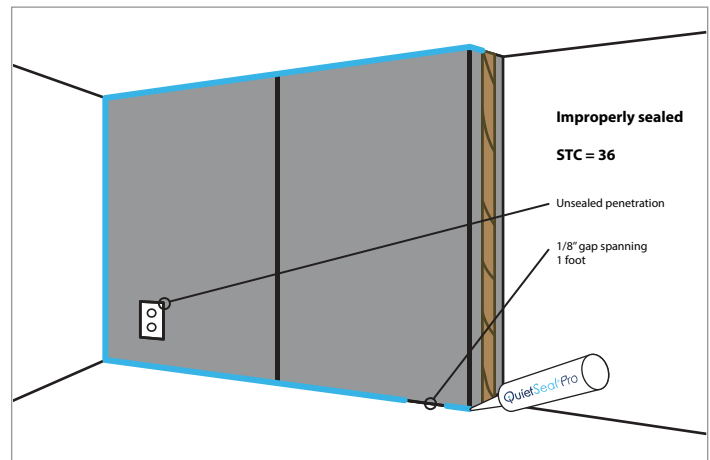

Figure 3: unsealed or improper application of acoustic sealant can open the path for sound to travel (flanking). The effects of sound leaks can reduce STC performance in any acoustically rated assembly.

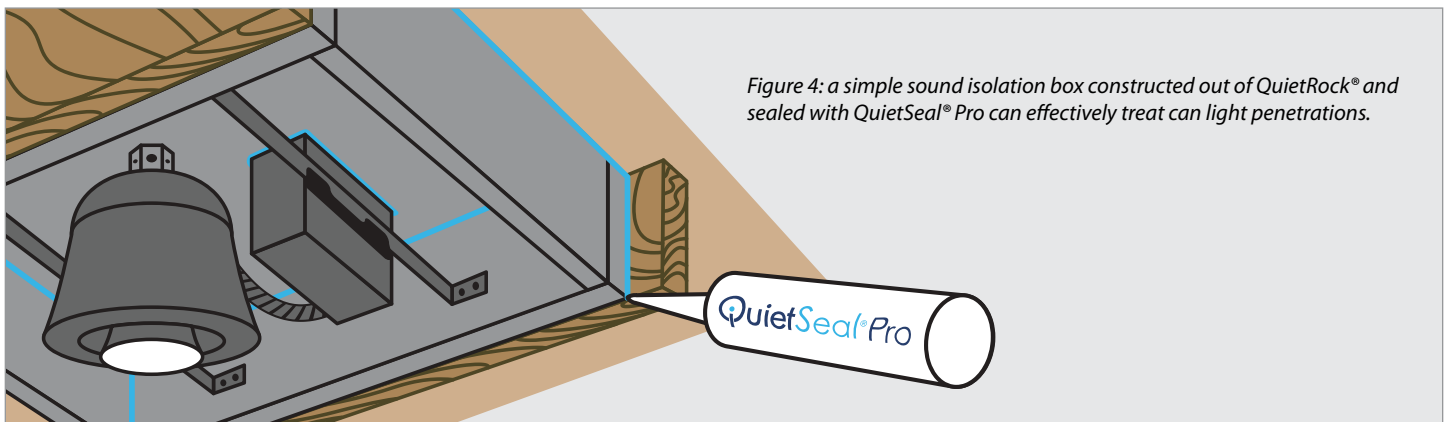
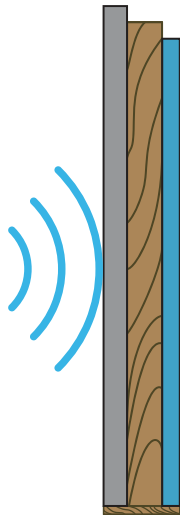

Figure 4: a simple sound isolation box constructed out of QuietRock® and sealed with QuietSeal® Pro can effectively treat can light penetrations.

Absorption, Reflection, Transmission

What is the difference?

ABSORPTION occurs when energy is converted into another form in a material. For sound, absorption converts the sound energy into very tiny amounts of heat.



REFLECTION happens when waves encounter rigid surfaces and bounce (reflect) back towards the incoming wave. Sound waves reflecting off of hard surfaces create echoes.

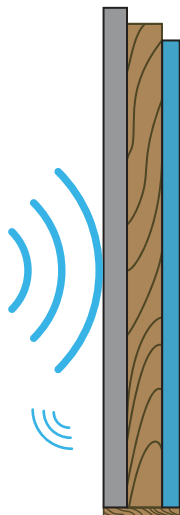

TRANSMISSION is the transfer of energy from one point to another. Sound energy transmits through building partitions at different levels depending on the partition design.

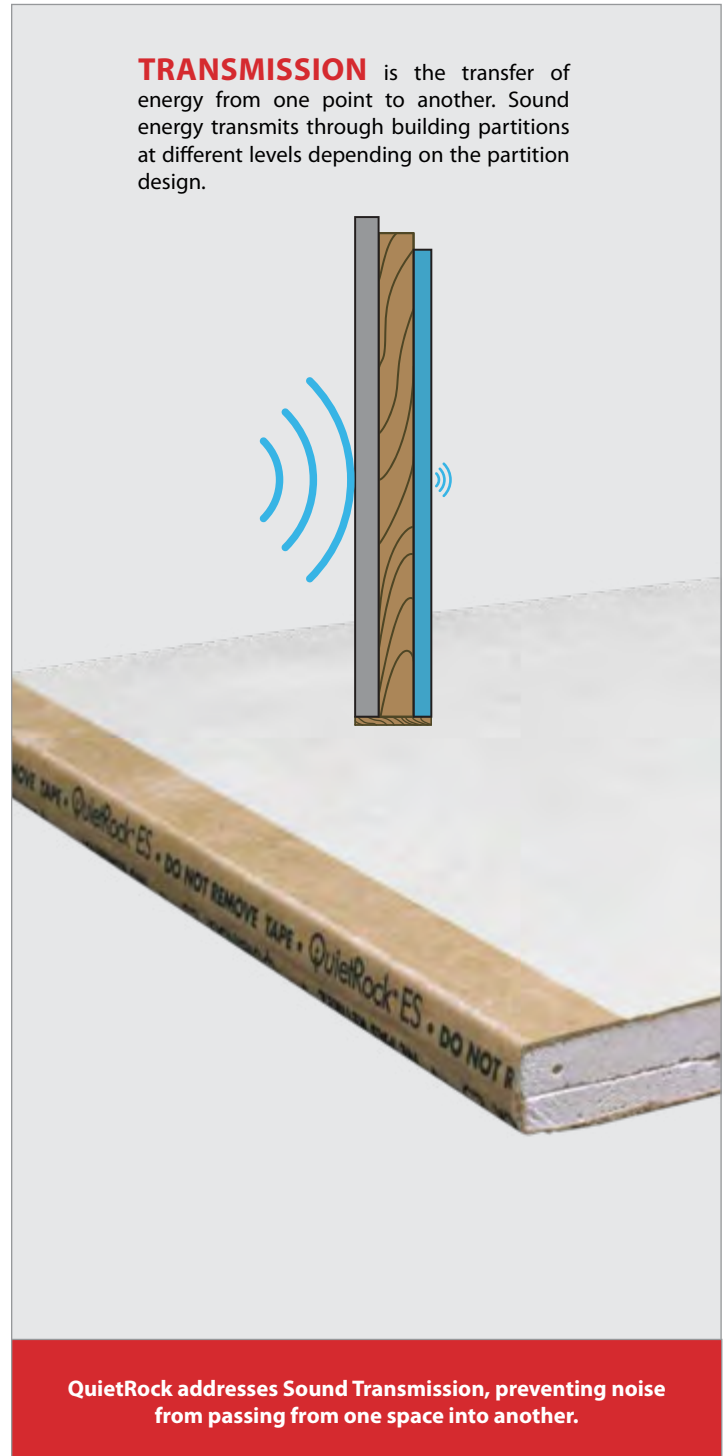

QuietRock addresses Sound Transmission, preventing noise from passing from one space into another.

Sound Transmission Class (STC)

How it is Measured?

Sound Transmission Class (STC) is a metric of how well a wall, partition or floor/ceiling system attenuates airborne sound over a range of frequencies, though it is ultimately the result at 500 Hz. STC is calculated from Sound Transmission Loss (STL) measurements using ASTM International Classification E413 (Classification for Rating Sound Insulation). The STC rating very roughly reflects the decibel reduction in noise that a partition can provide.

In order to calculate a single STC value, a series **Sound Transmission Loss (STL)** data points must first be collected in a lab between 125 Hz to 4,000 Hz.

The data collection process is done by producing sound in one room, let's call it the source room, and with a microphone in the adjacent room, measuring the amount of sound it allowed to penetrate through the demising wall. The demising wall is usually a very dense partition that if solid, would be just about as "soundproof" (see glossary) as you can get. This wall however has a large opening in the middle so that the test wall can be placed or built in the cavity.

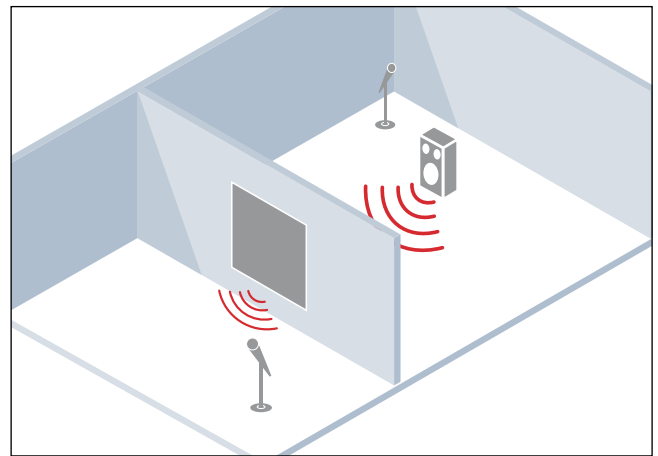

The STL measurements are plotted on a graph to graphically display the Sound **Transmission Loss Curve (TL Curve)**. Once plotted the STC Contour is superimposed over the TL Curve and adjusted up or down until 2 rules are satisfied:

1. There cannot be a deficiency greater than 8 dB at any measurement point.
2. The total of all deficiencies cannot exceed 32 dB.

Once those rules are satisfied and the STC Contour is set. The single number STC rating is determined by the dB reduction at the intersection of 500 Hz and the STC Contour. The higher the STC rating, the better the sound isolation of the wall partition.

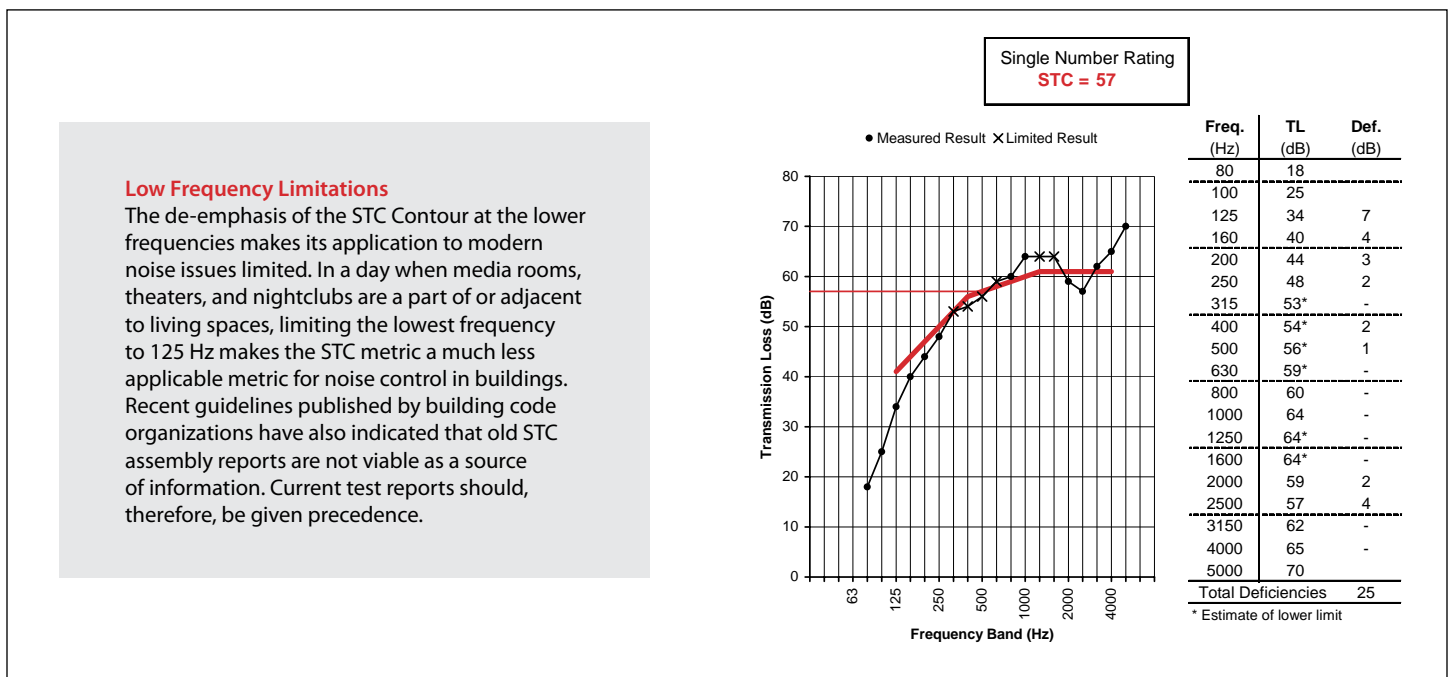

Contemporary Testing

The importance of using current data

THE IMPORTANCE OF CURRENT DATA

The construction industry, as a whole, creates many “handbooks” designed to navigate and execute the correct assembly for specific fire requirements and include STC ranges, when available. Although many assemblies found in current handbooks are sound tested and are often easy to specify and build, the bulk of acoustic testing performed dates back to the 1960’s - a commonly overlooked detail that can impact the actual acoustic performance of the wall.

Sound isolation measurements and testing standards have been continuously revised since their inception decades ago. Yet old tests using these outdated methodologies are considered “useable”. The way the Sound Transmission Loss (STL) of a partition was measured and the resulting Sound Transmission Class (STC) calculated, say from the 1960s will likely be different if tested using today’s standards. The ASTM standard for measuring laboratory STL changed the type of frequency range over the years. Another cause of a result difference can be attributed to the evolution of building materials over the past 40 years; for example, a type X drywall panel today is lighter than one produced when some of these tests were conducted. Any assembly tested before any of these changes were implemented could result in relying on inflated expectations and could be misleading.

Simply put, if a standard wall assembly achieved an STC 51 rating in 1968 and were sent back to laboratories for testing today, it would not achieve an STC rating above 46. So what may have been acceptable by the building code in the 1960s may not meet code today even though these assemblies are still presented in current industry handbooks.

What adds to the confusion is the fact that building partition materials such as studs, insulation, and gypsum wallboard have undergone changes in form and formula over the last 50 years. Steel studs, for example, have undergone major changes over time. Studs with “equivalent” stud gauge are now available as well as studs with varying hole shapes, lengths, and sizes over the length of the stud. All of these changes can affect the STL of building partitions to some degree or another. Choosing a specific resilient channel from the selection available today can result in drastically different STL results as well depending on the application.

How is a test report from 1963 going to account for all these factors? Due to a rising need for relevant and accurate data, organizations such as the International Code Council (ICC), have published guidelines for sound isolation in buildings that address the need for current data. According to the ICC G2-2010 Guideline for Acoustics, for example, a test report older than 20 years does not provide adequate validation for a design.

Further evidence of the need for current data is clear when comparing older traditionally-referenced STL test reports to current test reports of same assemblies, such as in the graph below.

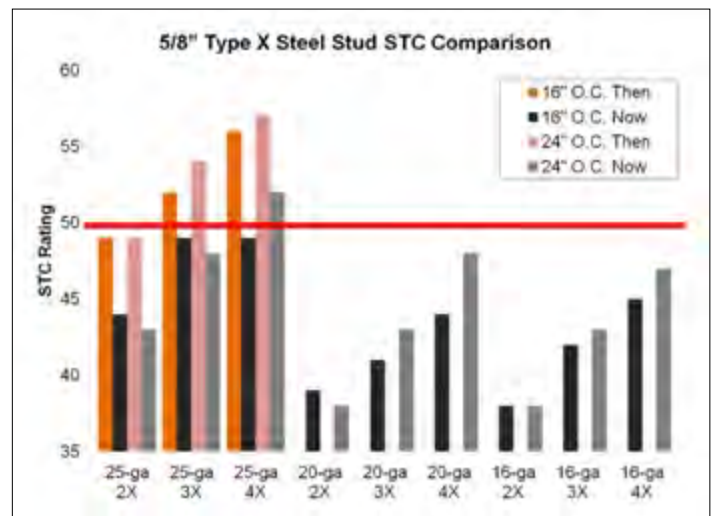

Understanding Acoustic Test Reports

A brief walk-through

Testing for Sound Transmission Loss (STL) is important both for the validation of assembly designs for use in building projects but also for the comparison of different building materials in a laboratory environment that is designed to minimize variability and bias. It is important, then, to understand the different pieces of an STL test report so that an appropriate analysis and conclusion can be reached regarding the efficacy of any particular building material for use as an acoustic treatment.

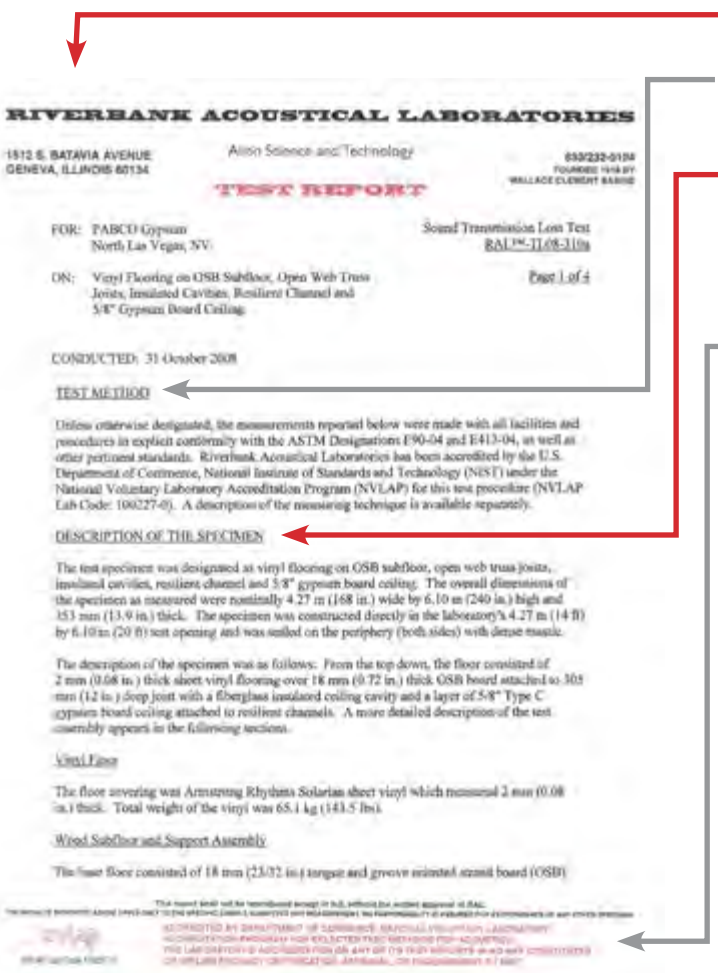

Lab Name and Date/Report information: identifies the name of the laboratory, the date of the test measurement and the report number

Test Method section: for sound transmission loss testing look here to ensure that the ASTM International Standards E90 and E413 were adhered to during testing.

Description of test Specimen: it is important to look thoroughly through the test specimen details to ensure that the assembly in question was built with the framing type, gauge, spacing, insulation type, panel configuration, and screw spacing were installed according to the desired partition type. The weights of assembly components is also provided for reference and comparison between tested materials.

Accreditation footnote: there are several laboratory accreditation organizations, such as NVLAP and IEC, available for accreditation. Accreditation ensures that the laboratory adheres to current and thorough measurement and test reporting guidelines and standards and that quality control is in place for test procedures.

TEST RESULTS							
Sound transmission loss values are tabulated at the eighteen standard frequencies. A graphic presentation of the data and additional information appear on the following pages. The precision of the TL test data is within the limits set by the ASTM Standard E90-04.							
FREQ.	T.L.	C.L.	DEF.	FREQ.	T.L.	C.L.	DEF.
100	23	0.57		800	54	0.23	1
125	33	0.78	4	1000	58	0.20	
160	36	0.72	4	1250	61	0.15	
200	40	0.42	3	1600	63	0.14	
250	43	0.47	3	2000	62	0.13	
315	44	0.52	5	2500	63	0.10	
400	48	0.42	4	3150	69	0.07	
500	51	0.29	2	4000	77	0.07	
630	53	0.29	1	5000	83	0.08	

STC-53

Test results (above): can be a bit confusing.

Freq. is the part of the table or column where the tested and reported frequencies (see glossary) are listed.

TL is the sound transmission loss (see glossary) data measured and calculated over the report frequency range.

CL is the reported confidence limit of the measurement data. It is an indication of the statistical accuracy of the measurements at each test frequency.

Def or Deficiencies are the values, in dB, of the portion of the TL curve that lies below the STC contour curve (see section on STC) at each measurement frequency.

The graph of test results, along with the STC contour are provided as well. At times a drawing or photograph of the test assembly is also attached as part of the report.

Sound Intensity

Determines post-construction flanking paths

Acoustical engineers and consultants routinely conduct sound intensity measurements to determine post-construction flanking paths. The **International Building Code (IBC)** requires a field-tested **noise isolation class (NIC)** or **normalized noise isolation class (NNIC)** performance rating of 45 for various types of demising partitions. These metrics are calculated from measurements made according to the ASTM International standard E336 Standard Test Method for Measurement of Airborne Sound Attenuation Between Rooms in Buildings. Other building codes such as the **International Green Construction Code (IgCC)** reference the ASHRAE 189.1 Standard for the Design of High Performance Green Buildings, with even more stringent and robust requirements for field testing sound isolation in buildings. It is important to understand the limitations of the ASTM E336 standard and explore standard test methodologies that more completely characterize the transmission of sound (including flanking sound) through partitions.

In ASTM E336 a microphone is used to measure the **sound pressure level (SPL)** in a source and receiving room. Microphones measure the sound pressure inside of any given space, but a microphone provides no significant information about which direction the sound radiation is coming from. For example, a microphone could be placed near a potential source of sound leakage in a room, but the output of the microphone (SPL) does not provide any information about where the actual sound is coming from nor how badly the sound is radiating from the flanking source. This makes microphones ineffective for determining sound flanking and leakage.

Fortunately, a measurement method was developed in the 1930s for measuring **sound intensity**. Microphones measure the sound pressure of a sound field in a room at a single location within the room. Sound intensity probes measure the radiated sound power from sound sources within the room. If sound is radiating from a source of sound flanking in a room, a sound intensity probe will provide information about how much greater the sound energy is near sources of sound flanking than it is over the rest of the partition. Because sound intensity (I) is the product of the sound pressure (p) and the velocity (v), sound intensity probes are made from either two phase-matched microphones facing each other or from the combination of a microphone and a particle velocity probe. Most modern sound intensity probes are the two-microphone type (p-p). A sound intensity probe can be used to scan the surface of a wall, floor, or ceiling to determine the location of sound leaks or flanking paths.

Some sound intensity probes come equipped with camera technology that allows you to create a color map of sound radiation over the building surface simultaneously while scanning the building surface with the probe. It is important to utilize the technology at our disposal to fully characterize field sound isolation in buildings.

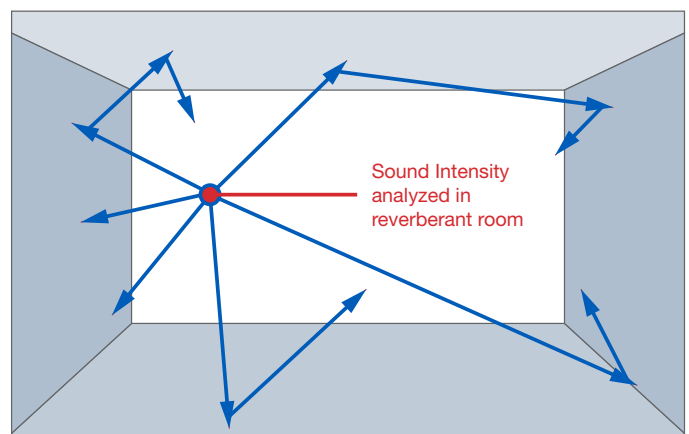
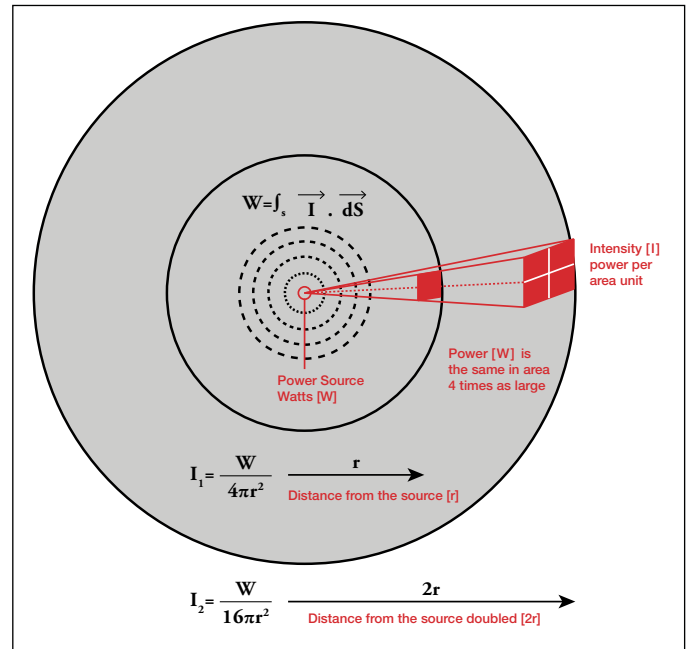

Key Factors that Contribute to STC

The effects of materials & design

SCREW SPACING

Screws spaced closer together will decrease STC & sound isolation.

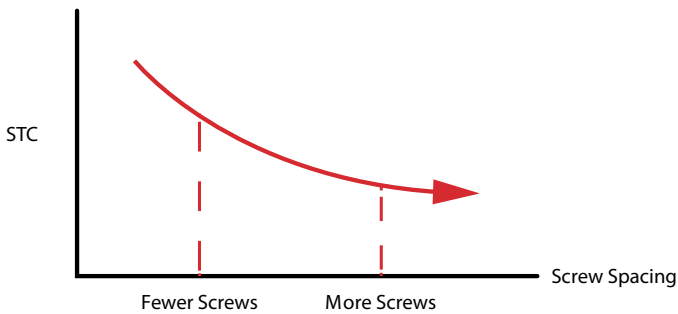

STUD/ JOIST DEPTH

Greater stud depth allows for more airspace and increased performance.

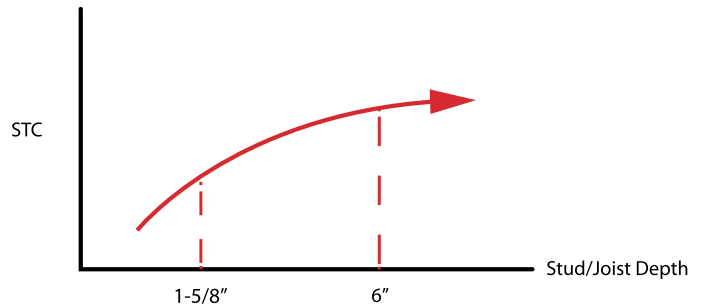

STUD/ JOIST SPACING

Wider stud spacing creates larger air cavities and decreased stiffness for better sound isolation.

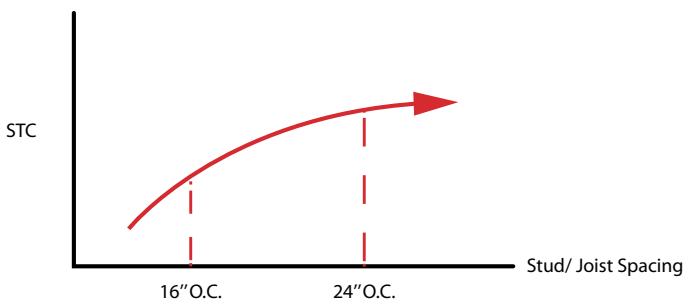

STUD/ JOIST TYPE

Steel studs allow greater flexibility and sound isolation without reducing structural integrity.

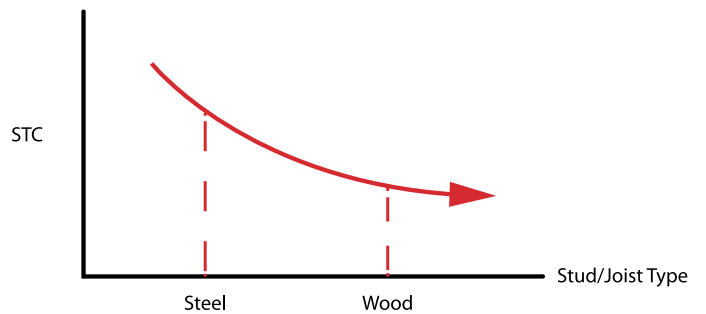

STUD CONFIGURATION

Separating stud frames adds decoupling and increased air space, increasing sound transmission loss.

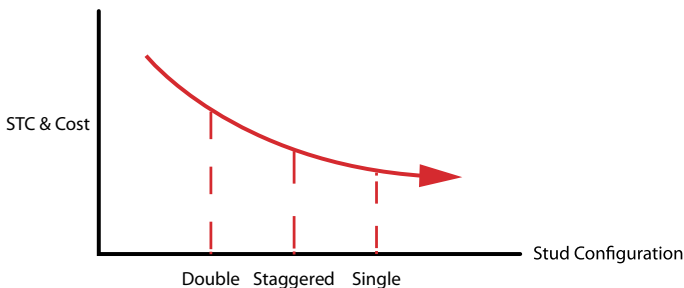

STUD GAUGE

Light gauge studs provide better sound isolation than heavy gauge studs.

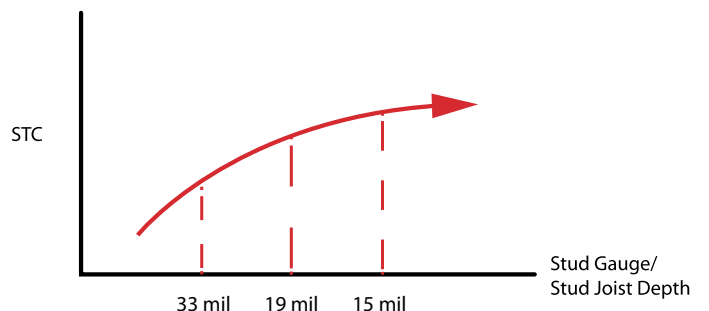

The higher the STC rating, the better the sound isolation of the partition.

The Impact of Steel Stud Selection

Sound transmission loss performance

Steel studs are designed and manufactured to be specified in a wide range of building projects. Information contained in the steel stud specification is crucial for architects and acoustical consultants as they collaborate with structural engineers to specify the appropriate steel framing members for buildings. This collaboration ensures that all partitions are fire-safety compliant and meet local codes and regulations – including Sound Transmission Class (STC) ratings. The selection and specification of steel framing components can have a direct impact on Sound Transmission Loss (STL) performance. Four key topics are addressed regarding the effect of steel-framed designs on sound transmission loss:

1. The effect of mil thickness on STL performance,
2. How mil thickness varies across steel manufacturers and what effect this has on STL performance,
3. The effect of steel spacing and width on STL performance, and
4. Laboratory testing concerns for the repeated use of the same steel frame over time.

The table below shows the difference between a drywall stud (non-structural, 15 mil to 23 mil) and structural stud (thicknesses greater than 23 mil). Use ASTM standard C645 for more restrictions on tolerances and variability with the structural steel studs.

Steel Stud Thickness	Drywall Gauge	Structural Gauge
15 mil	25 ga. EQ	-
18 mil	25 ga.	-
18 mil	20 ga. EQ	-
19 mil	20 ga. EQ	-
30 mil	-	20 ga. EQ
33 mil	-	20 ga.
43 mil	-	18 ga.
54 mil	-	16 ga.
68 mil	-	14 ga.
97 mil	-	12 ga.

The subject of steel thickness and gauge has only recently been introduced in building partition design. Many architectural drawings still list steel stud framing as “metal studs” or similar without any mention of steel mil thickness or gauge. PABCO® has conducted hundreds of ASTM E90 laboratory tests on varying steel mil thicknesses (even for the same specified stud gauge).

We found that even the specification of steel gauge can be problematic for accurate sound isolation design in buildings. For example, steel framing may be listed as “20 ga,” however, many steel manufacturers produce 20-ga steel from 19-mil thick up to 33-mil thick. Our testing has indicated that there is a very large difference in STC rating and STL performance for this large range of steel thicknesses. Steel gauge is, therefore, not an accurate, nor useful specification when it comes to sound isolation design. The steel mil thickness must be reported for greater accuracy and lower risk of field failure. That is why in this edition of The Sound Design Guide we use only mil thickness in our designs.

Another important finding relevant to mil thickness is that once the stud thickness is increased to around 33- to 43-mil thickness, any changes in performance for standard 5/8” Type X Gypsum Wallboard (GWB) partitions are very small, even for multiple panel configurations. A larger amount of variation exists, even across these thicker steel frames, when damped panels are used for higher STL and STC ratings.

Further, the mil thickness of steel framing varies across steel manufacturers for the same gauge specification. One manufacturer’s “20-ga” non-structural steel stud may perform drastically different from another manufacturer’s steel stud with the same gauge specification. It is increasingly important to either specify stud mil-thickness in building design or to specify a range of STC ratings for the same steel gauge specification if multiple steel manufacturers are specified as options for a project.

Beyond mil thickness, the spacing and width of steel studs can have varying influences on the STC rating and STL. For 15-mil non-structural stud framing, there is a smaller difference in STC rating and STL for 16” o.c. versus 24” o.c. stud spacing. However, once the mil thickness increases to 20-mil (and progressively as the mil-thickness increases), there exists much larger differences between the standard 16” o.c. and 24” o.c. stud spacing.

Initial findings also indicate that the repeated use of the same steel frame can influence the STL and STC rating of a partition. Most of our repeated testing has indicated that if you test one partition design, and then repeat this design after 4 or 5 uses of the same frame, the partition design first tested may increase by a significant amount of STC points. It is important to know how many times a particular steel frame had been used in a given test series, in order to assess how the STL or STC performance may have changed over the course of testing.

Speech Privacy Class

Methods and examples

The words “**speech privacy**” often invoke images of top-secret government facilities or open office cubicles. The importance of speech privacy in building construction, however, expands to a great many project types. **Healthcare** building projects are regulated by codes or guidelines, such as the Health Insurance Portability and Accountability Act (HIPAA), that require privacy for sensitive conversations in enclosed rooms. **Office buildings** with conference rooms and human resources departments have need of enclosures that are capable of keeping conversations private. **Classrooms** with poorly designed separation walls contribute to an environment of distraction, inhibiting concentration required to learning. **Hotels** and **multi-family** dwellings become a nearly unbearable source of frustration and stress when conversations and other more disturbing noises can be heard through interior partitions. Frustration and distraction don’t need to interfere with our everyday lives. Adhering to guidelines and validated partition designs using current measurement standards enables building industry professionals to ensure a secure and private environment for their building project needs.

STC was originally designed to characterize speech. Due to recent studies indicating that STC is not appropriate for characterizing speech privacy, a new standard was developed for speech privacy in enclosed spaces and a new rating system was created: the **Speech Privacy Class (SPC)**.

SPC is calculated by:

1. Measuring and averaging the background noise (Ln(ave)) over a range of frequencies, from 160 Hz to 5,000 Hz.
2. Measure and average the sound transmission loss (TL(ave)) over the same range of frequencies.
3. Simply add the two averaged values together and, if comparing laboratory-tested STL results, add one.

The graph below illustrates the different rating scales for the SPC.

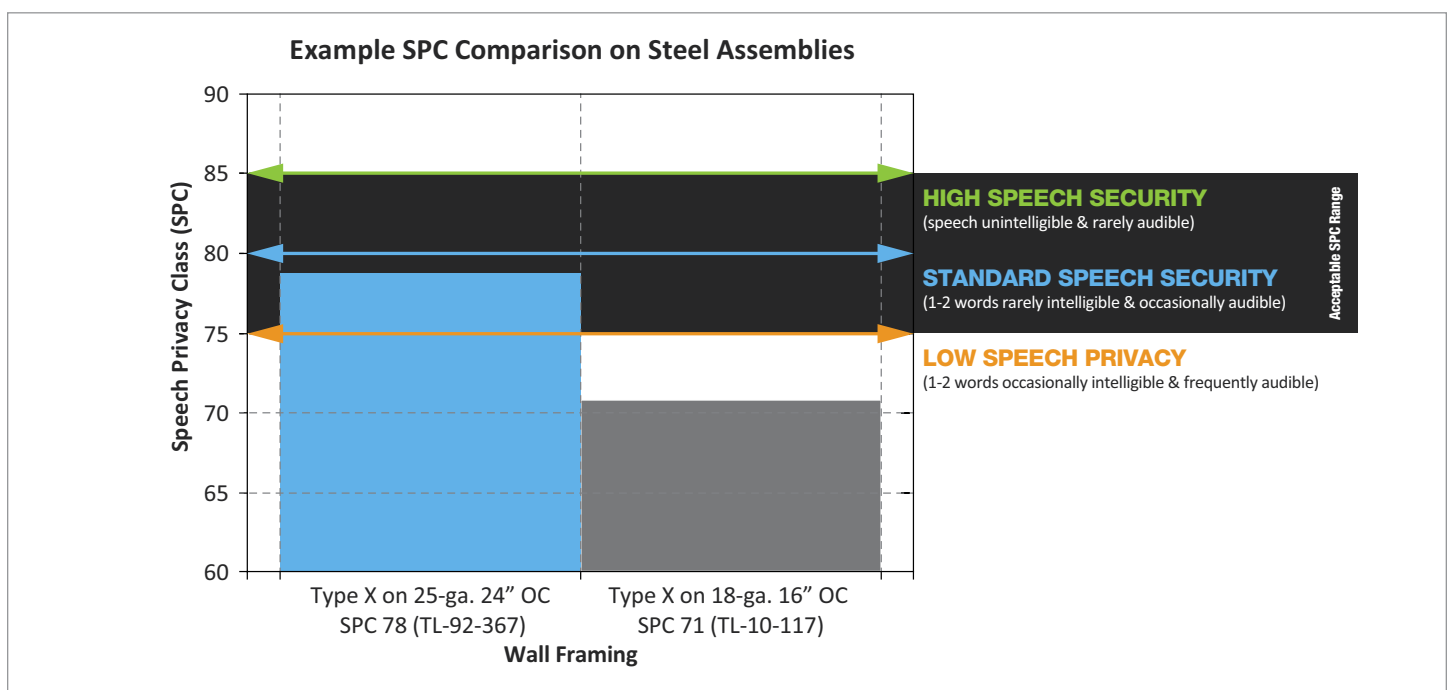
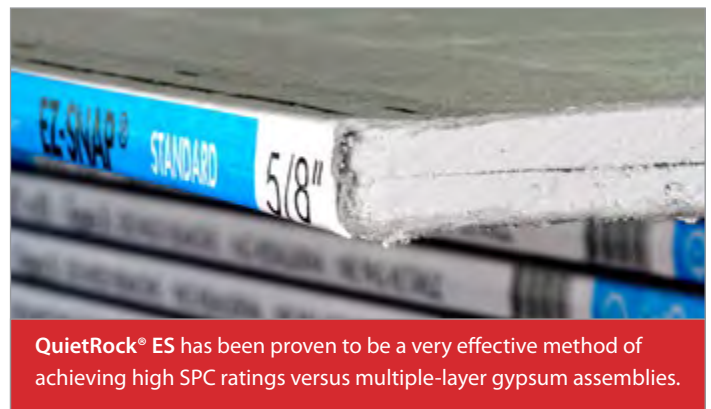



QUIET® WALLS QUIET® GUEST ROOMS

Quiet® guest rooms are one of the top amenities a hotel can offer. It can be a significant contributor to repeat business and positive reviews. Create a peaceful relaxing experience for guests by including walls with high STC ratings.

STOP the **SOUND** transfer from neighboring guest rooms and the corridor with **QUIETROCK® SOUND REDUCING DRYWALL**.

[Scan here to learn more](#)



- High acoustic performance
- Easy installation
- Low installed cost
- Saves floor space
- STC not affected by mounted fixtures
- Ideal for remodels-no demolition required

Constrained-Layer Damping

How QuietRock works

CONSTRAINED-LAYER DAMPING

Constrained-layer damping (CLD) is a vibration isolation technique that was originally developed for naval vessels and airplane fuselages. CLD requires the application of materials that are viscoelastic—materials that can deform easily when stressed and then return back into their original form. QuietRock® products, through the application of viscoelastic materials (QuietGlue®) in gypsum panels, use shear-loading and vibration decay to reduce noise by 10 dB or more versus traditional treatments. Simply, QuietRock® makes it easier for the building partition to reduce vibration, which makes sound isolation much more efficient.

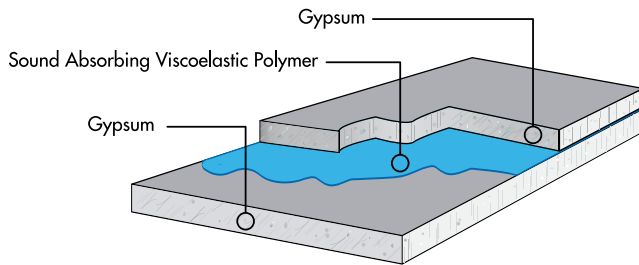

Figure 1: QuietRock uses advanced viscoelastic polymers (damping layer) between two layers of gypsum (constraining layers) to reduce sound vibrations in building partitions.

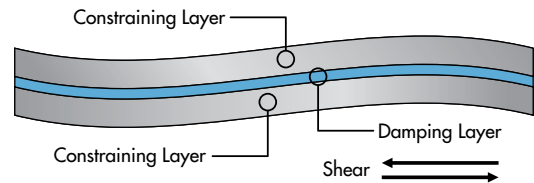

Figure 2: System under vibration (magnified). Note shearing of damping layer as panel flexes.

EXTENSIONAL FREE-LAYER DAMPING

Extensional damping is achieved by applying a damping compound, such as QuietCoat® to a non-porous metal or plastic substrate. Similar to CLD, extensional damping reduces vibration energy and sound. Examples of extensional damping in buildings include coating HVAC ducting, escalator & elevator wall panels, in wall pipes, and undercoating stainless steel sinks with QuietCoat. Extensional damping is appropriate in situations where the substrate is thin and non-porous.

Although extensional damping can be effective for some applications (listed above), it is not an effective sound isolation treatment for building partitions. It should, therefore, not be applied to a gypsum panel partitions. The gypsum panel is too thick in relation to the thickness of the coating and the panel surface too porous for the QuietCoat or other extensional damping material to function as a sound isolation treatment.



PABCO Gypsum Sound & Fire Designs

Old to new design number conversion table

Explanation of PABCO Gypsum Design Number

1. PGD=PABCO Gypsum Design. This will help identify the source of the design and eliminate confusion with other handbooks and guides.
2. Construction Type if other than a Wall Partition (for example an Area Separation Wall would be ASW)
3. Stud Type:
 - a. Wood=W
 - b. Steel=Noted by mil thickness
4. Stud Width:
 - a. Wood=If other than standard width of 4"
 - b. Steel=If other than standard width of 3-5/8"
5. Stud Configuration (if other than single)
 - a. S=Staggered
 - b. D=Double
6. Assembly Number within the Category (the lower the number, the higher the STC value)
7. Stud Spacing
 - a. 16" o.c.=16
 - b. 24" o.c.=24

OLD DESIGN NUMBER	NEW DESIGN NUMBER	PAGE #
PGD-01-00-010	PGD-15-590-24	48
PGD-01-00-012	PGD-15D-265-16	110
PGD-01-00-016	PGD-15D-423-16	112
PGD-01-00-018	PGD-15D-375-16	111
PGD-01-00-020	PGD-15-624-24	49
PGD-01-00-022	PGD-54D-286-16	121
PGD-01-00-030	PGD-15-624-16	49
PGD-01-10-003	PGD-15S-286-16	106
PGD-01-10-011	PGD-15-423-24	44
PGD-01-10-017	PGD-15S-337-16	107
PGD-01-10-021	PGD-15-485-24	47
PGD-01-10-023	PGD-15S-468-16	108
PGD-01-10-030	PGD-18-466-24	51
PGD-01-10-041	PGD-18-554-24	53
PGD-01-10-043	PGD-19-558-24	59
PGD-01-10-045	PGD-18-484-24	52
PGD-01-10-055	PGD-18-402-16	50
PGD-01-10-061	PGD-15-552-24	48

OLD DESIGN NUMBER	NEW DESIGN NUMBER	PAGE #
PGD-01-10-065	PGD-18-487-16	52
PGD-01-10-075	PGD-19-394-24	55
PGD-01-10-085	PGD-19-574-24	59
PGD-01-10-091	PGD-19-627-24	60
PGD-01-10-101	PGD-15-427-16	45
PGD-01-10-105	PGD-19-426-16	56
PGD-01-10-111	PGD-15-552-16	48
PGD-01-10-121	PGD-15-435-16	46
PGD-01-10-131	PGD-15-456-16	46
PGD-01-10-135	PGD-33-427-16	62
PGD-01-10-141	PGD-33-687-24	66
PGD-01-10-142	PGD-33D-317-16	116
PGD-01-10-145	PGD-43-584-16	75
PGD-01-10-151	PGD-43-595-16	75
PGD-01-10-155	PGD-436-485-16	77
PGD-01-10-161	PGD-436-517-24	77
PGD-01-10-165	PGD-436-592-24	78
PGD-01-10-171	PGD-436-716-24	79
PGD-01-10-181	PGD-436-598-24	79
PGD-01-10-191	PGD-33-516-24	63
PGD-01-10-196	PGD-19-447-24	57
PGD-01-10-201	PGD-33-573-24	64
PGD-01-10-205	PGD-43-394-16	73
PGD-01-10-211	PGD-19-627-16	60
PGD-01-10-212	PGD-43-824-16	76
PGD-01-10-213	PGD-19-447-16	57
PGD-01-10-215	PGD-43-476-16	74
PGD-01-10-221	PGD-19-574-16	59
PGD-01-10-225	PGD-33-513-16	62
PGD-01-10-231	PGD-33-573-16	64
PGD-01-10-235	PGD-33-687-16	66
PGD-01-10-240	PGD-546-493-16	90
PGD-01-10-250	PGD-546-576-16	90
PGD-01-10-251	PGD-54-516-16	82
PGD-01-10-255	PGD-54-406-16	81

PABCO Gypsum Sound & Fire Designs



Old to new design number conversion table - Continued

OLD DESIGN NUMBER	NEW DESIGN NUMBER	PAGE #
PGD-01-10-260	PGD-54-664-24	85
PGD-01-10-261	PGD-54-526-16	82
PGD-01-10-265	PGD-54-552-16	83
PGD-01-10-270	PGD-54-554-16	83
PGD-01-10-271	PGD-54-556-16	84
PGD-01-10-280	PGD-54-644-16	85
PGD-01-10-281	PGD-54-797-16	86
PGD-01-10-290	PGD-68-396-16	93
PGD-01-10-310	PGD-68-534-16	94
PGD-01-10-314	PGD-68-607-16	95
PGD-01-10-315	PGD-68-612-16	96
PGD-01-10-320	PGD-68-798-16	98
PGD-01-10-340	PGD-97-466-16	99
PGD-01-10-345	PGD-97-516-16	100
PGD-01-10-350	PGD-97-597-16	101
PGD-01-10-355	PGD-97-602-16	102
PGD-01-10-360	PGD-97-736-16	104
PGD-01-20-011	PGD-15-489-24	47
PGD-01-20-015	PGD-19-552-16	58
PGD-01-20-021	PGD-43-604-16	76
PGD-01-20-025	PGD-15-489-16	47
PGD-01-20-031	PGD-54-314-16	80
PGD-01-20-035	PGD-18-596-16	54
PGD-01-20-041	PGD-54-667-16	86
PGD-01-20-042	PGD-54D-317-16	122
PGD-01-20-048	PGD-54D-407-16	124
PGD-01-20-054	PGD-54D-394-16	123
PGD-01-20-055	PGD-33-358-16	61
PGD-01-20-061	PGD-33-598-16	65
PGD-01-20-064	PGD-33D-404-16	117
PGD-01-20-065	PGD-68-648-16	97
PGD-01-20-075	PGD-97-604-16	103
PGD-02-00-030	PGD-W-397-16	126
PGD-02-00-040	PGD-W-557-24	132
PGD-02-00-050	PGD-W-642-16	133
PGD-02-00-060	PGD-W-648-16	134
PGD-02-00-070	PGD-WS-467-16	146
PGD-02-10-012	PGD-WS-485-16	147
PGD-02-10-014	PGD-WS-537-16	148
PGD-02-10-022	PGD-WS-647-16	148
PGD-02-10-045	PGD-WD-354-16	150
PGD-02-10-055	PGD-WD-468-16	152

OLD DESIGN NUMBER	NEW DESIGN NUMBER	PAGE #
PGD-02-10-070	PGD-W-449-24	128
PGD-02-10-080	PGD-W-465-24	129
PGD-02-10-090	PGD-W-574-24	133
PGD-02-10-120	PGD-W-646-24	134
PGD-02-10-145	PGD-W-545-16	131
PGD-02-10-151	PGD-W-445-16	127
PGD-02-10-155	PGD-W-535-16	130
PGD-02-20-162	PGD-W-824-16	135
PGD-08-20-010	PGD-ASW-W-200-16	155

PABCO Gypsum Sound & Fire Designs

Sorted by fire ratings

DESIGN NUMBER	STC	PAGE #
---------------	-----	--------

2 Hour Assemblies

U301 - 2 Hour		
PGD-W-824-16	38	135

U347 - 2 Hour		
PGD-ASW-W-200-16	69	155

U411 - 2 Hour		
PGD-15-489-24	55	47
PGD-19-552-24	52	58
PGD-15-489-16	50	47
PGD-18-596-24	50	54
PGD-54-667-24	46	86
PGD-18-596-16	45	54
PGD-19-552-16	45	58
PGD-54-667-16	40	86

U425 - 2 Hour		
PGD-33-598-24	50	65
PGD-436-598-24	50	79
PGD-43-604-24	49	76
PGD-97-604-24	49	103
PGD-68-648-24	47	97
PGD-33-598-16	45	65
PGD-336-687-16	45	71
PGD-68-648-16	43	97
PGD-43-604-16	42	76
PGD-97-604-16	40	103

DESIGN NUMBER	STC	PAGE #
---------------	-----	--------

V464 - 2 Hour		
PGD-54D-394-16	60	123

W466 - 2 Hour		
PGD-33-358-16	62	61
PGD-546-353-16	62	87
PGD-54-314-16	60	80

1 Hour Assemblies

U305 - 1 Hour		
PGD-W-445-16	57	127
PGD-W-397-16	56	126
PGD-W6-485-16	55	139
PGD-W-535-16	53	130
PGD-W6-595-16	50	140
PGD-W6-467-16	49	138
PGD-W6-625-16	48	141
PGD-W-545-16	48	131
PGD-W6-672-16	46	142
PGD-W6-753-16	42	142
PGD-W-646-16	41	134
PGD-W6-824-16	38	143
PGD-W6-914-16	34	144

PABCO Gypsum Sound & Fire Designs

Sorted by fire ratings - continued



DESIGN NUMBER	STC	PAGE #
---------------	-----	--------

U309 - 1 Hour

PGD-W-397-24	60	126
PGD-W-449-24	57	128
PGD-W-465-24	56	129
PGD-W6-467-24	56	138
PGD-W6-565-24	52	140
PGD-W-574-24	51	133
PGD-W-574-16	45	133
PGD-W-646-24	47	134
PGD-W6-914-24	42	144

U340 - 1 Hour

PGD-WS-467-24	56	146
PGD-WS-485-24	55	147
PGD-WS-485-16	55	147
PGD-WS-467-16	53	146
PGD-WS-537-24	53	148
PGD-WS-537-16	51	148
PGD-WS-647-16	47	148
PGD-WS-647-24	47	148

U341 - 1 Hour

PGD-WD-354-16	62	150
PGD-WD-468-16	56	152

U425 - 1 Hour

PGD-546-407-16	60	88
PGD-33-427-16	58	62
PGD-336-423-16	58	69
PGD-334-442-16	57	67
PGD-43-394-16	57	73
PGD-54-406-16	56	81
PGD-68-396-16	56	93
PGD-97-466-16	56	99
PGD-436-485-24	55	77
PGD-546-493-24	55	90
PGD-436-517-24	54	77
PGD-546-427-16	54	89
PGD-97-516-24	54	100
PGD-68-534-24	53	94
PGD-33-558-16	52	63

DESIGN NUMBER	STC	PAGE #
---------------	-----	--------

PGD-54-516-16	52	82
PGD-54-552-16	52	83
PGD-54-552-24	52	83
PGD-54-554-24	52	83
PGD-54-556-24	52	84
PGD-33-573-24	51	64
PGD-334-572-16	51	67
PGD-43-476-16	51	74
PGD-546-576-24	51	90
PGD-436-592-24	50	78
PGD-68-534-16	50	94
PGD-97-516-16	50	100
PGD-97-597-24	50	101
PGD-336-492-16	50	70
PGD-68-607-24	49	95
PGD-334-624-16	48	68
PGD-546-493-16	48	90
PGD-546-587-16	48	91
PGD-43-584-16	47	75
PGD-54-644-24	47	85
PGD-97-597-16	47	101
PGD-436-485-16	46	77
PGD-54-664-24	46	85
PGD-54-644-16	46	85
PGD-68-607-16	46	95
PGD-33-687-24	45	66
PGD-43-595-16	45	75
PGD-54-554-16	45	83
PGD-54-556-16	45	84
PGD-68-612-16	45	96
PGD-436-716-24	44	79
PGD-546-576-16	44	90
PGD-33-573-16	43	64
PGD-546-738-24	43	92
PGD-97-602-16	43	102
PGD-97-736-24	43	104
PGD-336-757-16	42	72
PGD-54-664-16	41	85
PGD-334-790-16	40	68
PGD-54-797-24	40	86
PGD-68-798-24	40	98
PGD-43-824-24	38	76

PABCO Gypsum Sound & Fire Designs

Sorted by fire ratings - continued



DESIGN NUMBER	STC	PAGE #
PGD-43-824-16	38	76
PGD-68-798-16	38	98
PGD-97-736-16	38	104
PGD-54-797-16	35	86

U431 - 1 Hour		
PGD-WD-373-16	61	151

U465 - 1 Hour		
PGD-19-394-24	60	55
PGD-18-402-24	59	50
PGD-18-402-16	58	50
PGD-19-426-16	58	56
PGD-18-466-24	56	51
PGD-18-487-24	55	52
PGD-33-516-24	54	63
PGD-18-487-16	52	52
PGD-18-554-24	52	53
PGD-18-554-16	49	53
PGD-19-627-24	48	60
PGD-18-664-24	46	54
PGD-19-627-16	41	60
PGD-33-687-16	41	66
PGD-18-664-16	40	54

V464 - 1 Hour		
PGD-15D-265-16	66	110
PGD-15S-286-16	65	106
PGD-33D-317-16	64	116
PGD-54D-317-16	64	122
PGD-15S-337-16	63	107
PGD-15D-375-16	61	111
PGD-33D-404-16	59	117
PGD-15D-423-16	58	112
PGD-15-423-24	58	44
PGD-15-427-16	58	45
PGD-19-447-24	57	57
PGD-15S-468-16	56	108
PGD-15-485-24	55	47
PGD-18-484-24	55	52
PGD-15-435-16	54	46
PGD-33-513-16	54	62

DESIGN NUMBER	STC	PAGE #
PGD-546-425-16	54	89
PGD-15-456-16	53	46
PGD-19-558-24	53	59
PGD-15-485-16	52	47
PGD-15-552-24	52	48
PGD-19-574-24	51	59
PGD-54-526-16	51	82
PGD-19-447-16	50	57
PGD-15-624-24	48	49
PGD-15-552-16	48	48
PGD-19-558-16	48	59
PGD-546-595-16	47	91
PGD-15-624-16	45	49
PGD-19-574-16	45	59

Non-Rated Assemblies

PGD-54D-105-16	83	118
PGD-54D-147-16	80	119
PGD-33D-145-16	80	113
PGD-54D-172-16	73	120
PGD-33D-155-16	72	114
PGD-33D-265-16	66	115
PGD-54D-286-16	65	121
PGD-54D-407-16	59	124
PGD-W-557-24	52	132
PGD-15-590-24	50	48
PGD-W-548-16	46	132
PGD-W-557-16	45	132
PGD-W-642-16	42	133
PGD-W-648-16	41	134
PGD-W-844-16	37	136
PGD-W-914-16	34	137

PABCO Gypsum Sound & Fire Designs

New assemblies added

DESIGN NUMBER	STC	FIRE	PAGE #
15 MIL STEEL FRAMING			
PGD-15-485-16	41	1 Hr	V464 47
18 MIL STEEL FRAMING			
PGD-18-402-24	59	1 Hr	U465 50
PGD-18-487-24	55	1 Hr	U465 52
PGD-18-554-16	49	1 Hr	U465 53
PGD-18-596-24	50	2 Hr	U411 54
PGD-18-664-16	40	1 Hr	U465 54
PGD-18-664-24	46	1 Hr	U465 54
19 MIL STEEL FRAMING			
PGD-19-552-24	52	2 Hr	U411 58
PGD-19-558-16	48	1 Hr	V464 59
33 MIL 3-5/8" STEEL FRAMING			
PGD-33-558-16	52	1 Hr	U425 63
PGD-33-598-24	50	2 Hr	U425 65
33 MIL 4" STEEL FRAMING			
PGD-334-442-16	57	1Hr	U425 67
PGD-334-572-16	51	1Hr	U425 67
PGD-334-624-16	48	1Hr	U425 68
PGD-334-790-16	40	1Hr	U425 68
33 MIL 6" STEEL FRAMING			
PGD-336-423-16	58	1Hr	U425 69
PGD-336-492-16	50	1Hr	U425 70
PGD-336-687-16	45	2 Hr	U425 71
PGD-336-757-16	42	1Hr	U425 72

DESIGN NUMBER	STC	FIRE	PAGE #
43 MIL 3-5/8" STEEL FRAMING			
PGD-43-604-24	49	2 Hr	U425 76
PGD-43-824-24	38	1 Hr	U425 76
43 MIL 6" STEEL FRAMING			
PGD-436-485-24	55	1 Hr	U425 77
54 MIL 3-5/8" STEEL FRAMING			
PGD-54-552-24	52	1 Hr	U425 83
PGD-54-554-24	52	1 Hr	U425 83
PGD-54-556-24	52	1 Hr	U425 84
PGD-54-644-24	47	1 Hr	U425 85
PGD-54-664-16	41	1 Hr	U425 85
PGD-54-667-24	46	2 Hr	U411 86
PGD-54-797-24	40	1 Hr	U425 86
54 MIL 6" STEEL FRAMING			
PGD-546-353-16	62	2 Hr	W466 87
PGD-546-407-16	60	1 Hr	U425 88
PGD-546-425-16	54	1 Hr	V464 89
PGD-546-427-16	54	1 Hr	U425 89
PGD-546-493-24	55	1 Hr	U425 90
PGD-546-576-24	51	1 Hr	U425 90
PGD-546-587-16	48	1 Hr	U425 91
PGD-546-595-16	47	1 Hr	V464 91
PGD-546-738-24	43	1 Hr	U425 92
68 MIL 3-5/8" STEEL FRAMING			
PGD-68-534-24	53	1 Hr	U425 94
PGD-68-607-24	49	1 Hr	U425 95
PGD-68-648-24	47	2 Hr	U425 97
PGD-68-798-24	40	1 Hr	U425 98

PABCO Gypsum Sound & Fire Designs

New assemblies added - Continued



DESIGN NUMBER	STC	FIRE	PAGE #
97 MIL 3-5/8" STEEL FRAMING			
PGD-97-516-24	54	1 Hr U425	100
PGD-97-597-24	50	1 Hr U425	101
PGD-97-604-24	49	2 Hr U425	103
PGD-97-736-24	43	1 Hr U425	104
33 MIL 3-5/8" DOUBLE STEEL FRAMING			
PGD-33D-145-16	80	Non-Rated	113
PGD-33D-155-16	72	Non-Rated	114
PGD-33D-265-16	66	Non-Rated	115
54 MIL 3-5/8" DOUBLE STEEL FRAMING			
PGD-54D-105-16	83	Non-Rated	118
PGD-54D-147-16	80	Non-Rated	119
PGD-54D-172-16	73	Non-Rated	120

DESIGN NUMBER	STC	FIRE	PAGE #
2X4 WOOD FRAMING			
PGD-W-397-24	60	1 Hr U309	126
PGD-W-548-16	46	Non-Rated	132
PGD-W-557-16	45	Non-Rated	132
PGD-W-574-16	45	1 Hr U309	133
PGD-W-646-16	41	1 Hr U305	134
PGD-W-844-16	37	Non-Rated	136
PGD-W-914-16	34	Non-Rated	137
2X6 WOOD FRAMING			
PGD-W6-467-16	49	1 Hr U305	138
PGD-W6-467-24	56	1 Hr U309	138
PGD-W6-485-16	55	1 Hr U305	139
PGD-W6-565-24	52	1 Hr U309	140
PGD-W6-595-16	50	1 Hr U305	140
PGD-W6-625-16	48	1 Hr U305	141
PGD-W6-672-16	46	1 Hr U305	142
PGD-W6-753-16	42	1 Hr U305	142
PGD-W6-824-16	38	1 Hr U305	143
PGD-W6-914-16	34	1 Hr U305	144
PGD-W6-914-24	42	1 Hr U309	144
2X4 STAGGERED WOOD FRAMING			
PGD-WS-467-24	56	1Hr U340	146
PGD-WS-485-24	55	1Hr U340	147
PGD-WS-537-24	53	1Hr U340	148
PGD-WS-647-24	47	1Hr U340	148
2X4 DOUBLE WOOD FRAMING			
PGD-WD-373-16	61	1Hr U431	151

Walls & Interior Partitions

Single Steel Frame

ASSEMBLY COMPONENTS AND PICTOGRAMS

The assemblies in this guide have been divided into sections by framing material type and ordered by design file number. The assembly details are listed in order starting from the outermost layer (attachment); working from top to bottom and ending with the stud or insulation. Pictograms have been added to each assembly detail to provide visual separation of the individual assembly components.

Attachment: identifies screw/nail type, placement, and spacing for attachment of the face layer



Face Layer: Identifies the PABCO Gypsum product that may be used as a base layer (if applicable)



Attachment: identifies screw/nail type, placement, and spacing for attachment of the face layer



Base Layer: Identifies the PABCO Gypsum product that may be used as a base layer (if applicable)



Framing: Identifies stud framing material, size, thickness, spacing and/or unique framing methods



Insulation: Identifies insulation type, size used to fill assembly cavity (if applicable)



Decoupling: Resilient channel (if applicable)









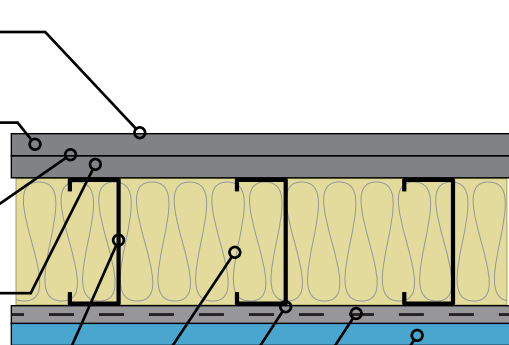

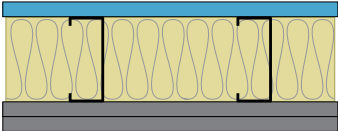







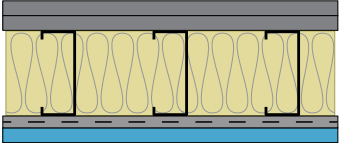

Attachment: Identifies screw type, placement, and spacing for attaching the Resilient Channel











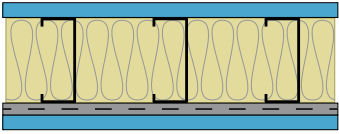







Face Layer: Identifies the QuietRock product use as a face layer

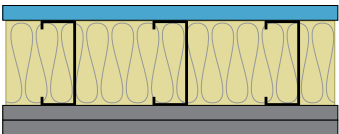









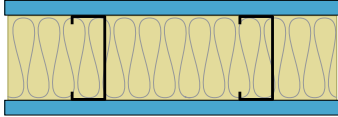
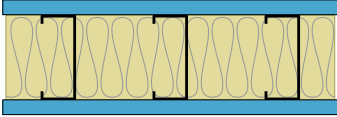





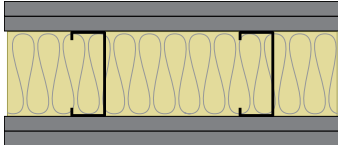
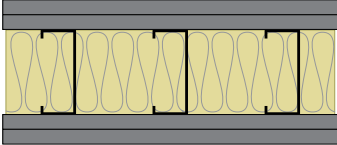

24" o.c.	16" o.c.	Description
<p data-bbox="196 342 375 369">PGD-15-423-24</p> <p data-bbox="228 432 342 464">STC 58</p> <p data-bbox="175 476 396 499">NOAL 17-0435 - 24" o.c.</p>  <p data-bbox="134 772 415 863">Fire: 1 Hour - UL V464 Configuration A GA WP-1002</p> <p data-bbox="134 907 370 963">Thickness: 5-1/2" Approx weight: 7.5 lb/ft²</p>		<ul style="list-style-type: none"> <li data-bbox="878 373 1471 422"> 1" Type S screws (for fire, minimum 1-1/4" Type S screws) spaced 8" o.c. at edges and 12" o.c. in the field. <li data-bbox="878 464 1487 512"> One layer: 5/8" QuietRock® ES or QuietRock® ES MR type X gypsum panel applied vertically. <li data-bbox="878 554 1243 602"> 3-5/8" 15 mil steel studs, 24" o.c. <li data-bbox="878 665 1503 714"> 3-1/2", R-13 glass fiber insulation friction fit into stud cavity. <li data-bbox="878 756 1479 846"> Base layer: 5/8" type X (FLAME CURB®, MOLD CURB® Plus, ABUSE CURB®, PABCO® Impact Resistant, PABCO® Glass Interior, PABCO® Glass Sheathing or PABCO® Gypsum Sheathing) gypsum panel applied vertically. <li data-bbox="878 867 1471 915"> 1" Type S screws (for fire, minimum 1-1/4" Type S screws) spaced 16" o.c. <li data-bbox="878 957 1479 1047"> Face layer: 5/8" type X (FLAME CURB®, MOLD CURB® Plus, ABUSE CURB®, PABCO® Impact Resistant, PABCO® Glass Interior, PABCO® Glass Sheathing or PABCO® Gypsum Sheathing) gypsum panel applied vertically.
<p data-bbox="289 1073 688 1129">Non-Load Bearing Vertical joints staggered on opposite sides</p>		<ul style="list-style-type: none"> <li data-bbox="878 1073 1511 1121"> 1-5/8" Type S screws (for fire, minimum 1-7/8" Type S screws) spaced 8" o.c. at edges and 12" o.c. in the field.







24" o.c.	16" o.c.	Description
	<p style="text-align: center;">PGD-15-427-16</p> <p style="text-align: center;">STC 58 NOAL 18-0846 - 16" o.c.</p>  <p style="text-align: center;">Fire: 1 Hour - UL V464 Configuration A</p> <p>Thickness: 6" Approx weight: 7.6 lb/ft²</p>	<ul style="list-style-type: none">  1-5/8" Type S screws (for fire, minimum 1-7/8" Type S screws) spaced 8" o.c. at edges and 12" o.c. in the field.  Face layer: 5/8" type X (FLAME CURB®, MOLD CURB® Plus, ABUSE CURB®, PABCO® Impact Resistant, PABCO® Glass Interior, PABCO® Glass Sheathing or PABCO® Gypsum Sheathing) gypsum panel applied vertically.  1" Type S screws (for fire, minimum 1-1/4" Type S screws) spaced 16" o.c.  Base layer: 5/8" type X (FLAME CURB®, MOLD CURB® Plus, ABUSE CURB®, PABCO® Impact Resistant, PABCO® Glass Interior, PABCO® Glass Sheathing or PABCO® Gypsum Sheathing) gypsum panel applied vertically.  3-5/8" 15 mil steel studs, 16" o.c.  3-1/2", R-13 glass fiber insulation friction fit into stud cavity.  Resilient channel applied at right-angle, 24" o.c.  1/2" #8 Type S pan head screw attaching Resilient Channel to stud flange at alternate intersections.  One layer: 5/8" QuietRock® ES or QuietRock® ES MR type X gypsum panel applied vertically.
<p>Non-Load Bearing Vertical joints staggered on opposite sides</p>		<ul style="list-style-type: none">  1" Type S drywall screws at 12" o.c.



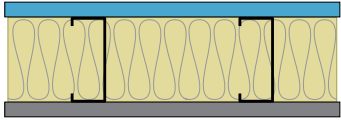
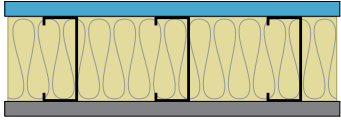



24" o.c.	16" o.c.	Description
	<p align="center">PGD-15-435-16</p> <p align="center">STC 54 NOAL 18-0844 - 16" o.c.</p>  <p align="center">Fire: 1 Hour - UL V464 Configuration A</p> <p align="center">Thickness: 5-3/8" Approx weight: 6.0 lb/ft²</p>	<ul style="list-style-type: none">  1" Type S screws (for fire, minimum 1-1/4" Type S screws) spaced 8" o.c. at edges and 12" o.c. in the field.  One layer: 5/8" QuietRock® ES or QuietRock® ES MR type X gypsum panel applied vertically.  3-5/8" 15 mil steel studs, 16" o.c.  33-1/2", R-13 glass fiber insulation friction fit into stud cavity.  Resilient channel applied at right-angle, 24" o.c.  1/2" Type S screws attaching resilient channel to stud at each intersection.  One layer: 5/8" QuietRock® ES or QuietRock® ES MR type X gypsum panel applied vertically.
<p align="center">Non-Load Bearing Vertical joints staggered on opposite sides</p>		<ul style="list-style-type: none">  1" Type S drywall screws at 12" o.c.



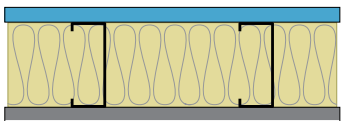



	<p align="center">PGD-15-456-16</p> <p align="center">STC 53 NOAL 17-0453 - 16" o.c.</p>  <p align="center">Fire: 1 Hour - UL V464 Configuration A GA WP-1028</p> <p align="center">Thickness: 5-1/2" Approx weight: 7.4 lb/ft²</p>	<ul style="list-style-type: none">  1" Type S screws (for fire, minimum 1-1/4" Type S screws) spaced 8" o.c. at edges and 12" o.c. in the field.  One layer: 5/8" QuietRock® ES or QuietRock® ES MR type X gypsum panel applied vertically.  3-5/8" 15 mil steel studs, 16" o.c.  3-1/2", R-11 glass fiber insulation friction fit into stud cavity.  Base layer: 5/8" type X (FLAME CURB®, MOLD CURB® Plus, ABUSE CURB®, PABCO® Impact Resistant, PABCO® Glass Interior, PABCO® Glass Sheathing or PABCO® Gypsum Sheathing) gypsum panel applied vertically.  1" Type S screws (for fire, minimum 1-1/4" Type S screws) spaced 8" o.c. at edges and 12" o.c. in the field.  Face layer: 5/8" type X (FLAME CURB®, MOLD CURB® Plus, ABUSE CURB®, PABCO® Impact Resistant, PABCO® Glass Interior, PABCO® Glass Sheathing or PABCO® Gypsum Sheathing) gypsum panel applied vertically.
<p align="center">Non-Load Bearing Vertical joints staggered on opposite sides</p>		<ul style="list-style-type: none">  1-5/8" Type S screws (for fire, minimum 1-7/8" Type S screws) spaced 8" o.c. at edges and 12" o.c. in the field.



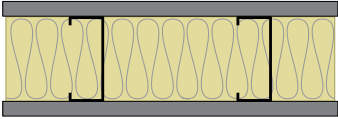
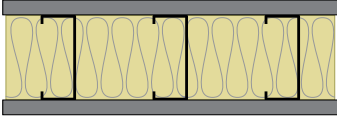





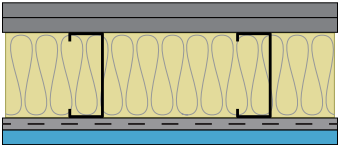
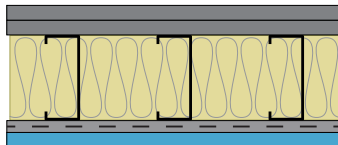

24" o.c.	16" o.c.	Description
<p>PGD-15-485-24</p> <p>STC 55 NOAL 18-0517 - 24" o.c.</p>  <p>Fire: 1 Hour - UL V464 Configuration A</p> <p>Thickness: 4-7/8" Approx weight: 5.7 lb/ft²</p>	<p>PGD-15-485-16</p> <p>STC 52 NOAL 19-0405 - 16" o.c.</p>  <p>Fire: 1 Hour - UL V464 Configuration A</p> <p>Thickness: 4-7/8" Approx weight: 6.0 lb/ft²</p>	<ul style="list-style-type: none">  1" Type S drywall screws (for fire, minimum 1-1/4" Type S screws) spaced 8" o.c. at edges and 12" o.c. in the field.  One layer: 5/8" QuietRock® ES or QuietRock® ES MR type X gypsum panel applied vertically.  3-5/8" 15 mil steel studs, 24" o.c. or 16" o.c.  3-1/2", R-13 glass fiber insulation friction fit into stud cavity.  One layer: 5/8" QuietRock® ES or QuietRock® ES MR type X gypsum panel applied vertically.  1" Type S drywall screws (for fire, minimum 1-1/4" Type S screws) spaced 8" o.c. at edges and 12" o.c. in the field.
<p>Non-Load Bearing Vertical joints staggered on opposite sides</p>		









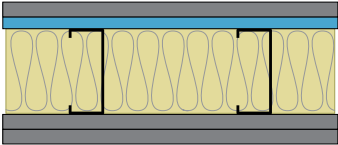

<p>PGD-15-489-24</p> <p>STC 55 NOAL 17-0434 - 24" o.c.</p>  <p>Fire: 2 Hour - UL U411</p> <p>Thickness: 6-1/8" Approx weight: 9.0 lb/ft²</p>	<p>PGD-15-489-16</p> <p>STC 50 NOAL 19-0408 - 16" o.c.</p>  <p>Fire: 2 Hour - UL U411</p> <p>Thickness: 6-1/8" Approx weight: 8.9 lb/ft²</p>	<ul style="list-style-type: none">  1-5/8" Type S screws spaced 8" o.c. at edges and 12" o.c. in the field (for fire, 1-5/8" type S screws spaced 16" o.c. in the field and along the vertical edges and 12" o.c. along top and bottom runners.)  Face layer: 5/8" type X (FLAME CURB®, PABCO® Glass Interior or PABCO® Glass Sheathing) gypsum panel applied vertically.  1" Type S screws spaced 8" o.c. at edges and 12" o.c. in the field (for fire, minimum 1" Type S screws spaced 16" o.c.)  Base layer: 5/8" type X (FLAME CURB®, PABCO® Glass Interior or PABCO® Glass Sheathing) gypsum panel applied vertically.  3-5/8" 15 mil steel studs, 24" o.c. or 16" o.c.  3-1/2", R-13 glass fiber insulation friction fit into stud cavity.  Base layer: 5/8" type X (FLAME CURB®, PABCO® Glass Interior or PABCO® Glass Sheathing) gypsum panel applied vertically.  1" Type S screws spaced 8" o.c. at edges and 12" o.c. in the field (for fire, minimum 1" Type S screws spaced 16" o.c.)  Face layer: 5/8" type X (FLAME CURB®, PABCO® Glass Interior or PABCO® Glass Sheathing) gypsum panel applied vertically.  1-5/8" Type S screws spaced 8" o.c. at edges and 12" o.c. in the field (for fire, 1-5/8" type S screws spaced 16" o.c. in the field and along the vertical edges and 12" o.c. along top and bottom runners.)
<p>Non-Load Bearing Vertical joints staggered on opposite sides</p>		







24" o.c.	16" o.c.	Description
<p>PGD-15-552-24</p> <p>STC 52 NOAL 18-0519 - 24" o.c.</p>  <p>Fire: 1 Hour - UL V464 Configuration A</p> <p>Thickness: 4-7/8" Approx weight: 5.2 lb/ft²</p>	<p>PGD-15-552-16</p> <p>STC 48 NOAL 19-0406 - 16" o.c.</p>  <p>Fire: 1 Hour - UL V464 Configuration A</p> <p>Thickness: 4-7/8" Approx weight: 5.4 lb/ft²</p>	<ul style="list-style-type: none">  1-1/4" Type S drywall screws spaced 8" o.c. at edges and 12" o.c. in the field.  One layer: 5/8" QuietRock® ES or QuietRock® ES MR type X gypsum panel applied vertically.  3-5/8" 15 mil steel studs, 24" o.c. or 16" o.c.  3-1/2", R-13 glass fiber insulation friction fit into stud cavity.  One layer: 5/8" type X (FLAME CURB®, MOLD CURB® Plus, ABUSE CURB®, PABCO® Impact Resistant, PABCO® Glass Interior, PABCO® Glass Sheathing or PABCO® Gypsum Sheathing) gypsum panel applied vertically.  1-1/4" Type S drywall screws spaced 8" o.c. at edges and 12" o.c. in the field.
<p>Non-Load Bearing Vertical joints staggered on opposite sides</p>		



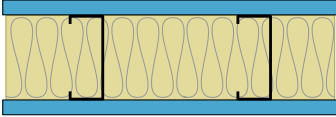





<p>PGD-15-590-24</p> <p>STC 50 OL-12-0515 - 24" o.c.</p>  <p>Fire: Non-Rated</p> <p>Thickness: 4-5/8" Approx weight: 4.3 lb/ft²</p>		<ul style="list-style-type: none">  1-1/4" Type S drywall screws 12" o.c.  One layer: 1/2" QuietRock® 510 gypsum panel applied vertically.  3-5/8" 15 mil steel studs, 24" o.c.  3-1/2", R-13 glass fiber insulation friction fit into stud cavity.  One layer: 1/2" PABCO® Regular, FLAME CURB® Super C or PABCO® Glass Interior gypsum panel applied vertically.  1-1/4" Type S drywall screws 12" o.c.
<p>Non-Load Bearing Vertical joints staggered on opposite sides</p>		

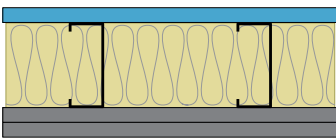
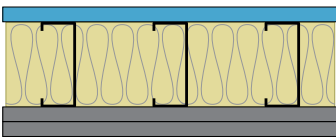





24" o.c.	16" o.c.	Description
<p>PGD-15-624-24</p> <p>STC 48 NOAL 18-0520 - 24" o.c.</p>  <p>Fire: 1 Hour - UL V464 Configuration A</p> <p>Thickness: 4-7/8" Approx weight: 4.7 lb/ft²</p>	<p>PGD-15-624-16</p> <p>STC 45 NOAL 19-0407 - 16" o.c.</p>  <p>Fire: 1 Hour - UL V464 Configuration A</p> <p>Thickness: 4-7/8" Approx weight: 4.8 lb/ft²</p>	<ul style="list-style-type: none">  1-1/4" Type S drywall screws spaced 8" o.c. at edges and 12" o.c. in the field.  One layer: 5/8" type X (FLAME CURB®, MOLD CURB® Plus, ABUSE CURB®, PABCO® Impact Resistant, PABCO® Glass Interior, PABCO® Glass Sheathing or PABCO® Gypsum Sheathing) gypsum panel applied vertically.  3-5/8" 15 mil steel studs, 24" o.c. or 16" o.c.  3-1/2", R-13 glass fiber insulation friction fit into stud cavity.  One layer: 5/8" type X (FLAME CURB®, MOLD CURB® Plus, ABUSE CURB®, PABCO® Impact Resistant, PABCO® Glass Interior, PABCO® Glass Sheathing or PABCO® Gypsum Sheathing) gypsum panel applied vertically.  1-1/4" Type S drywall screws spaced 8" o.c. at edges and 12" o.c. in the field.
<p>Non-Load Bearing Vertical joints staggered on opposite sides</p>		



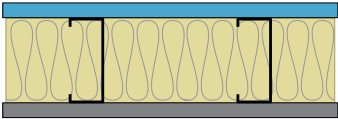
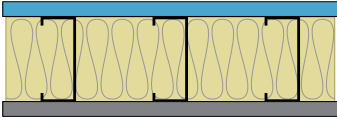





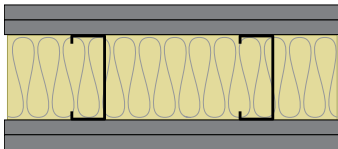
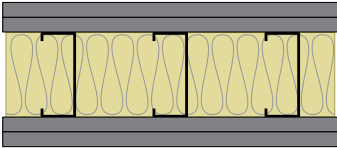

24" o.c.	16" o.c.	Description
<p data-bbox="196 348 375 378">PGD-18-402-24</p> <p data-bbox="228 571 342 604">STC 59</p> <p data-bbox="172 615 399 640">NOAL 19-0321 - 24" o.c.</p>  <p data-bbox="133 947 347 972">Fire: 1 Hour - UL U465</p> <p data-bbox="133 1012 370 1073">Thickness: 6" Approx weight: 7.4 lb/ft²</p>	<p data-bbox="578 348 756 378">PGD-18-402-16</p> <p data-bbox="610 571 724 604">STC 58</p> <p data-bbox="553 615 781 640">NOAL 18-0855 - 16" o.c.</p>  <p data-bbox="514 947 729 972">Fire: 1 Hour - UL U465</p> <p data-bbox="514 1012 748 1073">Thickness: 6" Approx weight: 7.7 lb/ft²</p>	<ul style="list-style-type: none"> <li data-bbox="878 380 1484 426"> 1-5/8" Type S screws spaced 8" o.c. at edges and 12" o.c. in the field. <li data-bbox="878 474 1507 520"> Face layer: 5/8" type X (FLAME CURB®, PABCO® Glass Interior, PABCO® Glass Sheathing) gypsum panel applied vertically. <li data-bbox="878 569 1495 615"> 1" Type S drywall screws spaced 8" o.c. at edges and 12" o.c. in the field <li data-bbox="878 663 1507 709"> Base layer: 5/8" type X (FLAME CURB®, PABCO® Glass Interior, PABCO® Glass Sheathing) gypsum panel applied vertically. <li data-bbox="878 758 1338 804"> 3-5/8" 18 mil steel studs, 24" o.c. or 16" o.c. <li data-bbox="878 852 1495 898"> 3-1/2", R-13 glass fiber insulation friction fit into stud cavity. <li data-bbox="878 947 1390 993"> Resilient channel applied at right-angle, 24" o.c. <li data-bbox="878 1041 1463 1087"> 1/2" Type S screws attaching resilient channel to stud at each intersection. <li data-bbox="878 1136 1484 1182"> One layer: 5/8" QuietRock® ES or QuietRock® ES MR type X gypsum panel applied vertically.
<p data-bbox="289 1283 688 1339">Non-Load Bearing Vertical joints staggered on opposite sides</p>		<ul style="list-style-type: none"> <li data-bbox="878 1283 1312 1329"> 1" Type S drywall screws spaced 12" o.c.







24" o.c.	16" o.c.	Description
<p>PGD-18-466-24</p> <p>STC 56 RAL TL-07-031 - 24" o.c.</p>  <p>Fire: 1 Hour - UL U465</p> <p>Thickness: 6" Approx weight: 8.9 lb/ft²</p>		<ul style="list-style-type: none">  2-1/2 in. Type S drywall screws 16" o.c. (for fire, minimum 1-1/2" Type S screws spaced 8" o.c. at edges and 12" o.c. in the field).  Face layer: 5/8" type X (FLAME CURB®, PABCO® Glass Interior or PABCO® Glass Sheathing) gypsum panel applied vertically.  1-5/8" Type S drywall screws 16" o.c. (for fire, 1" minimum Type S drywall screws).  Base layer: 1/2" QuietRock® 510 applied vertically.  3-5/8" 18 mil steel studs, 24" o.c.  3-1/2", R-13 glass fiber insulation friction fit into stud cavity.  Base layer: 5/8" type X (FLAME CURB®, PABCO® Glass Interior or PABCO® Glass Sheathing) gypsum panel applied vertically.  1-5/8" Type S drywall screws 16" o.c. (for fire, 1" Type S drywall screws)  Face layer: 5/8" type X (FLAME CURB®, PABCO® Glass Interior or PABCO® Glass Sheathing) gypsum panel applied vertically.
<p>Non-Load Bearing Vertical joints staggered on opposite sides</p>		<ul style="list-style-type: none">  2-1/2 in. Type S drywall screws at 16" o.c. (for fire, minimum 1-5/8" Type S screws spaced 8" o.c. at edges and 12" o.c. in the field).



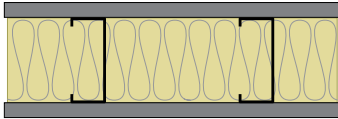
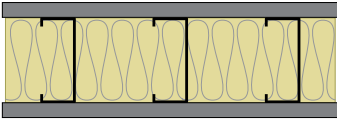





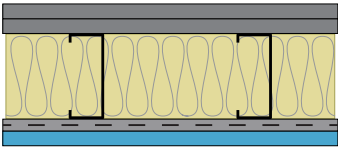

24" o.c.	16" o.c.	Description
<p>PGD-18-484-24</p> <p>STC 55 NRC-TLA-05-050 - 24" o.c.</p>  <p>Fire: 1 Hour - UL V464 Configuration A</p> <p>Thickness: 4-7/8" Approx weight: 6.2 lb/ft²</p>		<ul style="list-style-type: none">  Minimum 1-1/4" Type S drywall screws 8" at edges and 12" in the field.  One layer: 5/8" QuietRock® 530 or QuietRock® 530 RF gypsum panel applied vertically.  3-5/8" 18 mil. steel studs, 24" o.c.  3-1/2", R-13 glass fiber insulation friction fit into stud cavity.  One layer: 5/8" QuietRock® 530 or QuietRock® 530 RF gypsum panel applied vertically.
<p>Non-Load Bearing Vertical joints staggered on opposite sides</p>		<ul style="list-style-type: none">  Minimum 1-1/4" Type S drywall screws 8" at edges and 12" in the field.









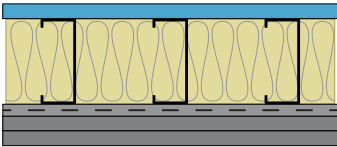

PGD-18-487-24	PGD-18-487-16	
<p>STC 55 NOAL 19-0327 - 24" o.c.</p>  <p>Fire: 1 Hour - UL U465</p> <p>Thickness: 5-1/2" Approx weight: 7.4 lb/ft²</p>	<p>STC 52 NOAL 18-0860 - 16" o.c.</p>  <p>Fire: 1 Hour - UL U465</p> <p>Thickness: 5-1/2" Approx weight: 7.5 lb/ft²</p>	<ul style="list-style-type: none">  1" Type S screws spaced 8" o.c. at edges and 12" o.c. in the field.  One layer: 5/8" QuietRock® ES or QuietRock® ES MR type X gypsum panel applied vertically.  3-5/8" 18 mil steel studs, 24" o.c. or 16" o.c.  3-1/2", R-13 glass fiber insulation friction fit into stud cavity.  Base layer: 5/8" type X (FLAME CURB®, PABCO® Glass Interior, PABCO® Glass Sheathing) gypsum panel applied vertically.  1" Type S screws spaced 8" o.c. at edges and 12" o.c. in the field.  Face layer: 5/8" type X (FLAME CURB®, PABCO® Glass Interior, PABCO® Glass Sheathing) gypsum panel applied vertically.
<p>Non-Load Bearing Vertical joints staggered on opposite sides</p>		<ul style="list-style-type: none">  1-5/8" Type S screws spaced 8" o.c. at edges and 12" o.c. in the field.









24" o.c.	16" o.c.	Description
<p>PGD-18-554-24</p> <p>STC 52 NOAL 18-0522 - 24" o.c.</p>  <p>Fire: 1 Hour - UL U465</p> <p>Thickness: 4-7/8" Approx weight: 5.2 lb/ft²</p>	<p>PGD-18-554-16</p> <p>STC 49 NOAL 19-0422 - 16" o.c.</p>  <p>Fire: 1 Hour - UL U465</p> <p>Thickness: 4-7/8" Approx weight: 5.4 lb/ft²</p>	<ul style="list-style-type: none">  1-1/4" Type S drywall screws spaced 8" o.c. at edges and 12" o.c. in the field.  One layer: 5/8" QuietRock® ES or QuietRock® ES MR type X gypsum panel applied vertically.  3-5/8" 18 mil steel studs, 24" o.c. or 16" o.c.  3-1/2", R-13 glass fiber insulation friction fit into stud cavity.  One layer: 5/8" type X (FLAME CURB®, PABCO® Glass Interior, PABCO® Glass Sheathing) gypsum panel applied vertically.
<p>Non-Load Bearing Vertical joints staggered on opposite sides</p>		<ul style="list-style-type: none">  1-1/4" Type S drywall screws spaced 8" o.c. at edges and 12" o.c. in the field.

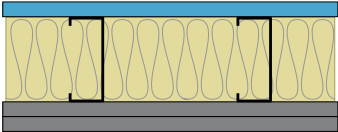
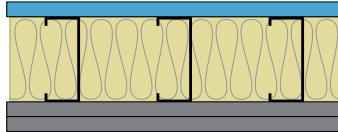







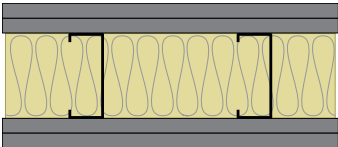
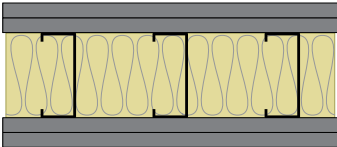

24" o.c.	16" o.c.	Description
<p>PGD-18-596-24</p> <p>STC 50 NOAL 20-1207 - 24" o.c.</p>  <p>Fire: 2 Hour - UL U411</p> <p>Thickness: 6-1/8" Approx weight: 9.0 lb/ft²</p>	<p>PGD-18-596-16</p> <p>STC 45 NOAL 18-0528 - 16" o.c.</p>  <p>Fire: 2 Hour - UL U411</p> <p>Thickness: 6-1/8" Approx weight: 8.9 lb/ft²</p>	<ul style="list-style-type: none">  1-5/8" Type S screws spaced 8" o.c. at edges and 12" o.c. in the field (for fire, 1-5/8" type S screws spaced 16" o.c. in the field and along the vertical edges and 12" o.c. along top and bottom runners.)  Face layer: 5/8" type X (FLAME CURB®, PABCO® Glass Interior, PABCO® Glass Sheathing) gypsum panel applied vertically.  1-1/4" Type S screws spaced 8" o.c. at edges and 12" o.c. in the field (for fire, minimum 1" Type S screws spaced 16" o.c.)  Base layer: 5/8" type X (FLAME CURB®, PABCO® Glass Interior, PABCO® Glass Sheathing) gypsum panel applied vertically.  3-5/8" 18 mil steel studs, 24" o.c. or 16" o.c.  3-1/2", R-13 glass fiber insulation friction fit into stud cavity.  Base layer: 5/8" type X (FLAME CURB®, PABCO® Glass Interior, PABCO® Glass Sheathing) gypsum panel applied vertically.  1-1/4" Type S screws spaced 8" o.c. at edges and 12" o.c. in the field (for fire, minimum 1" Type S screws spaced 16" o.c.)  Face layer: 5/8" type X (FLAME CURB®, PABCO® Glass Interior, PABCO® Glass Sheathing) gypsum panel applied vertically.  1-5/8" Type S screws spaced 8" o.c. at edges and 12" o.c. in the field (for fire, 1-5/8" type S screws spaced 16" o.c. in the field and along the vertical edges and 12" o.c. along top and bottom runners.)
<p>Non-Load Bearing Vertical joints staggered on opposite sides</p>		







<p>PGD-18-664-24</p> <p>STC 46 NOAL 20-1206 - 24" o.c.</p>  <p>Fire: 1 Hour - UL U465</p> <p>Thickness: 4-7/8" Approx weight: 4.8 lb/ft²</p>	<p>PGD-18-664-16</p> <p>STC 40 NOAL 19-0411 - 16" o.c.</p>  <p>Fire: 1 Hour - UL U465</p> <p>Thickness: 4-7/8" Approx weight: 4.8 lb/ft²</p>	<ul style="list-style-type: none">  1-1/4" Type S screws spaced 8" o.c. at edges and 12" o.c. in the field (for fire, minimum 1" Type S screws)  One layer: 5/8" type X (FLAME CURB®, PABCO® Glass Interior, PABCO® Glass Sheathing) gypsum panel applied vertically.  3-5/8" 18 mil steel studs, 24" o.c. or 16" o.c.  3-1/2", R-13 glass fiber insulation friction fit into stud cavity.  One layer: 5/8" type X (FLAME CURB®, PABCO® Glass Interior, PABCO® Glass Sheathing) gypsum panel applied vertically.  1-1/4" Type S screws spaced 8" o.c. at edges and 12" o.c. in the field (for fire, minimum 1" Type S screws)
<p>Non-Load Bearing Vertical joints staggered on opposite sides</p>		



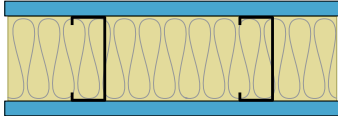
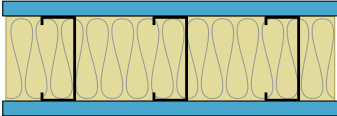



24" o.c.	16" o.c.	Description
<p>PGD-19-394-24</p> <p>STC 60 NOAL 17-0530 - 24" o.c.</p>  <p>Fire: 1 Hour - UL U465 GA WP-0951</p> <p>Thickness: 6" Approx weight: 7.8 lb/ft²</p>		<ul style="list-style-type: none">  1-5/8" Type S screws spaced 8" o.c. at edges and 12" o.c. in the field.  Face layer: 5/8" type X (FLAME CURB®, PABCO® Glass Interior, PABCO® Glass Sheathing) gypsum panel applied vertically.  1" Type S screws spaced 8" o.c. at edges and 12" o.c. in the field.  Base layer: 5/8" type X (FLAME CURB®, PABCO® Glass Interior, PABCO® Glass Sheathing) gypsum panel applied vertically.  3-5/8" 19 mil steel studs, 24" o.c.  3-1/2", R-13 glass fiber insulation friction fit into stud cavity.  Resilient channel applied at right-angle, 24" o.c.  1/2" Type S screws attaching resilient channel to stud at each intersection.  One layer: 5/8" QuietRock® ES or QuietRock® ES MR type X gypsum panel applied vertically.
<p>Non-Load Bearing Vertical joints staggered on opposite sides</p>		<ul style="list-style-type: none">  1" Type S screws spaced 12" o.c.



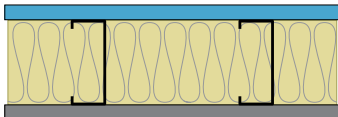
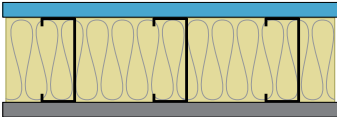



24" o.c.	16" o.c.	Description
	<p data-bbox="578 348 756 375">PGD-19-426-16</p> <p data-bbox="613 583 721 615">STC 58</p> <p data-bbox="557 625 777 653">NOAL 17-0509 – 16" o.c.</p>  <p data-bbox="516 926 761 982">Fire: 1 Hour - UL U465 GA WP-1001</p> <p data-bbox="516 1024 748 1081">Thickness: 6" Approx weight: 7.8 lb/ft²</p>	<ul style="list-style-type: none"> <li data-bbox="878 380 1446 426"> 1" Type S screws spaced 8" o.c. at edges and 12" o.c. in the field. <li data-bbox="878 468 1487 514"> One layer: 5/8" QuietRock® ES or QuietRock® ES MR type X gypsum panel applied vertically. <li data-bbox="878 556 1243 602"> 3-5/8" 19 mil steel studs, 16" o.c. <li data-bbox="878 665 1500 711"> 3-1/2", R-11 glass fiber insulation friction fit into stud cavity. <li data-bbox="878 774 1390 821"> Resilient channel applied at right-angle, 24" o.c. <li data-bbox="878 884 1495 930"> 1/2" Type S-12 screw attaching Resilient Channel to stud at each intersection. <li data-bbox="878 993 1511 1039"> Base layer: 5/8" type X (FLAME CURB®, PABCO® Glass Interior, PABCO® Glass Sheathing) gypsum panel applied vertically. <li data-bbox="878 1102 1479 1148"> 1" Type S screws spaced 8" o.c. at edges and 12" o.c. in the field. <li data-bbox="878 1211 1511 1257"> Face layer: 5/8" type X (FLAME CURB®, PABCO® Glass Interior, PABCO® Glass Sheathing) gypsum panel applied vertically.
<p data-bbox="289 1304 688 1360">Non-Load Bearing Vertical joints staggered on opposite sides</p>		<ul style="list-style-type: none"> <li data-bbox="878 1304 1487 1350"> 1-5/8" Type S screws spaced 8" o.c. at edges and 12" o.c. in the field.







24" o.c.	16" o.c.	Description
<p data-bbox="196 348 375 375">PGD-19-447-24</p> <p data-bbox="228 459 342 491">STC 57</p> <p data-bbox="172 501 399 527">NOAL 17-0539 – 24" o.c.</p>  <p data-bbox="134 800 415 890">Fire: 1 Hour - UL V464 Configuration A GA WP-0975</p> <p data-bbox="134 932 370 993">Thickness: 5-1/2" Approx weight: 7.6 lb/ft²</p>	<p data-bbox="578 348 756 375">PGD-19-447-16</p> <p data-bbox="610 459 724 491">STC 50</p> <p data-bbox="553 501 781 527">NOAL 17-0459 – 16" o.c.</p>  <p data-bbox="513 800 797 858">Fire: 1 Hour - UL V464 Configuration A</p> <p data-bbox="513 932 751 993">Thickness: 5-1/2" Approx weight: 7.6 lb/ft²</p>	<ul style="list-style-type: none"> <li data-bbox="878 375 1484 426"> 1" Type S screws spaced 8" o.c. at edges and 12" o.c. in the field. (for fire, minimum 1-1/4" Type S screws) <li data-bbox="878 474 1484 525"> One layer: 5/8" QuietRock® ES or QuietRock® ES MR type X gypsum panel applied vertically. <li data-bbox="878 573 1333 623"> 3-5/8" 19 mil steel studs, 24" o.c. or 16" o.c. <li data-bbox="878 672 1500 722"> 3-1/2", R-13 glass fiber insulation friction fit into stud cavity. <li data-bbox="878 770 1511 821"> Base layer: 5/8" type X (FLAME CURB®, PABCO® Glass Interior or PABCO® Glass Sheathing) gypsum panel applied vertically <li data-bbox="878 869 1484 919"> 1" Type S screws spaced 8" o.c. at edges and 12" o.c. in the field. (for fire, minimum 1-1/4" Type S screws) <li data-bbox="878 968 1511 1018"> Face layer: 5/8" type X (FLAME CURB®, PABCO® Glass Interior or PABCO® Glass Sheathing) gypsum panel applied vertically
<p data-bbox="289 1089 688 1148">Non-Load Bearing Vertical joints staggered on opposite sides</p>		<ul style="list-style-type: none"> <li data-bbox="878 1089 1500 1140"> 1-5/8" Type S drywall screws spaced 8" o.c. at edges and 12" o.c. in the field.

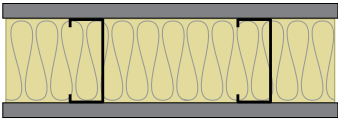
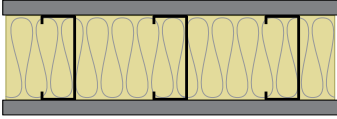

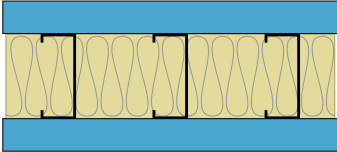





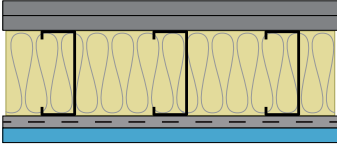

24" o.c.	16" o.c.	Description
<p data-bbox="198 346 371 373">PGD-19-552-24</p> <p data-bbox="228 594 342 627">STC 52</p> <p data-bbox="172 638 399 663">NOAL 19-0927 – 24" o.c.</p>  <p data-bbox="133 936 345 961">Fire: 2 Hour - UL U411</p> <p data-bbox="133 1001 370 1060">Thickness: 6-1/8" Approx weight: 9.1 lb/ft²</p>	<p data-bbox="579 346 753 373">PGD-19-552-16</p> <p data-bbox="610 594 724 627">STC 45</p> <p data-bbox="553 638 781 663">NOAL 19-0428 – 16" o.c.</p>  <p data-bbox="514 936 727 961">Fire: 2 Hour - UL U411</p> <p data-bbox="514 1001 750 1060">Thickness: 6-1/8" Approx weight: 9.0 lb/ft²</p>	<ul style="list-style-type: none"> <li data-bbox="873 380 1484 426"> 1-5/8" Type S screws spaced 8" o.c. at edges and 12" o.c. in the field. <li data-bbox="873 472 1507 518"> Face layer: 5/8" type X (FLAME CURB®, PABCO® Glass Interior, PABCO® Glass Sheathing) gypsum panel applied vertically. <li data-bbox="873 594 1446 640"> 1" Type S screws spaced 8" o.c. at edges and 12" o.c. in the field. <li data-bbox="873 716 1507 762"> Base layer: 5/8" type X (FLAME CURB®, PABCO® Glass Interior, PABCO® Glass Sheathing) gypsum panel applied vertically. <li data-bbox="873 808 1338 854"> 3-5/8" 19 mil steel studs, 24" o.c. or 16" o.c. <li data-bbox="873 909 1500 955"> 3-1/2", R-11 glass fiber insulation friction fit into stud cavity. (24" o.c. studs were tested with 3-1/2" R-13) <li data-bbox="873 1010 1507 1056"> Base layer: 5/8" type X (FLAME CURB®, PABCO® Glass Interior, PABCO® Glass Sheathing) gypsum panel applied vertically. <li data-bbox="873 1102 1446 1148"> 1" Type S screws spaced 8" o.c. at edges and 12" o.c. in the field. <li data-bbox="873 1203 1507 1249"> Face layer: 5/8" type X (FLAME CURB®, PABCO® Glass Interior, PABCO® Glass Sheathing) gypsum panel applied vertically.
<p data-bbox="289 1293 688 1352" style="text-align: center;">Non-Load Bearing Vertical joints staggered on opposite sides</p>		<ul style="list-style-type: none"> <li data-bbox="873 1293 1484 1339"> 1-5/8" Type S screws spaced 8" o.c. at edges and 12" o.c. in the field.







24" o.c.	16" o.c.	Description
<p>PGD-19-558-24</p> <p>STC 53 NOAL 19-0922 – 24" o.c.</p>  <p>Fire: 1 Hour - UL V464 Configuration A</p> <p>Thickness: 4-7/8" Approx weight: 6.0 lb/ft²</p>	<p>PGD-19-558-16</p> <p>STC 48 NOAL 19-0425 – 16" o.c.</p>  <p>Fire: 1 Hour - UL V464 Configuration A</p> <p>Thickness: 4-7/8" Approx weight: 6.1 lb/ft²</p>	<ul style="list-style-type: none">  1-1/4" Type S screws spaced 8" o.c. at edges and 12" o.c. in the field.  One layer: 5/8" QuietRock® ES or QuietRock® ES MR type X gypsum panel applied vertically.  3-5/8" 19 mil steel studs 24" o.c. or 16" o.c.  3-1/2", R-13 glass fiber insulation friction fit into stud cavity.  One layer: 5/8" QuietRock® ES or QuietRock® ES MR type X gypsum panel applied vertically.  1-1/4" Type S screws spaced 8" o.c. at edges and 12" o.c. in the field.
<p>Non-Load Bearing Vertical joints staggered on opposite sides</p>		

<p>PGD-19-574-24</p> <p>STC 51 NOAL 17-0538 – 24" o.c.</p>  <p>Fire: 1 Hour - UL V464 Configuration A</p> <p>Thickness: 4-7/8" Approx weight: 5.5 lb/ft²</p>	<p>PGD-19-574-16</p> <p>STC 45 NOAL 19-0426 – 16" o.c.</p>  <p>Fire: 1 Hour - UL V464 Configuration A</p> <p>Thickness: 4-7/8" Approx weight: 5.5 lb/ft²</p>	<ul style="list-style-type: none">  1-1/4" Type S screws spaced 8" o.c. at edges and 12" o.c. in the field.  One layer: 5/8" QuietRock® ES or QuietRock® ES MR type X gypsum panel applied vertically.  3-5/8" 19 mil steel studs, 24" o.c. or 16" o.c.  3-1/2", R-13 glass fiber insulation friction fit into stud cavity.  One layer: 5/8" type X (FLAME CURB®, PABCO® Glass Interior, or PABCO® Glass Sheathing) gypsum panel applied vertically.  1-1/4" Type S screws spaced 8" o.c. at edges and 12" o.c. in the field.
<p>Non-Load Bearing Vertical joints staggered on opposite sides</p>		

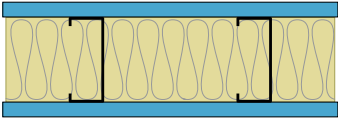
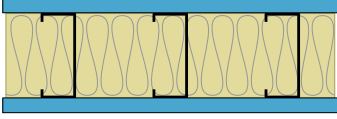
24" o.c.	16" o.c.	Description
<p>PGD-19-627-24</p>	<p>PGD-19-627-16</p>	<ul style="list-style-type: none">  1" Type S screws spaced 8" o.c. at edges and 12" o.c. in the field.  One layer: 5/8" type X (FLAME CURB®, PABCO® Glass Interior, PABCO® Glass Sheathing) gypsum panel applied vertically.  3-5/8" 19 mil steel studs, 24" o.c. or 16" o.c.  3-1/2", R-13 glass fiber insulation friction fit into stud cavity.  One layer: 5/8" type X (FLAME CURB®, PABCO® Glass Interior, PABCO® Glass Sheathing) gypsum panel applied vertically.  1" Type S screws spaced 8" o.c. at edges and 12" o.c. in the field.
<p>STC 48 NOAL 17-0523 - 24" o.c.</p>  <p>Fire: 1 Hour - UL U465</p> <p>Thickness: 4-7/8" Approx weight: 4.9 lb/ft²</p>	<p>STC 41 NOAL 19-0427 - 16" o.c.</p>  <p>Fire: 1 Hour - UL U465</p> <p>Thickness: 4-7/8" Approx weight: 4.9 lb/ft²</p>	
<p>Non-Load Bearing Vertical joints staggered on opposite sides</p>		







24" o.c.	16" o.c.	Description						
	<p align="center">PGD-33-358-16</p> <p align="center">STC 62</p> <p align="center">NOAL 18-0903- 16" o.c.</p> <p align="center">Low Frequency Transmission Loss</p> <table border="0" style="margin-left: auto; margin-right: auto;"> <tr> <td align="center">Hz</td> <td align="center">TL</td> </tr> <tr> <td align="center">80</td> <td align="center">29</td> </tr> <tr> <td align="center">100</td> <td align="center">37</td> </tr> </table>  <p align="center">Fire: 2 Hour - UL W466</p> <p align="center">Thickness: 6-3/8"</p> <p align="center">Approx weight: 13.3 lb/ft²</p>	Hz	TL	80	29	100	37	<ul style="list-style-type: none">  1-7/8" Type S drywall screws (for fire, minimum 2" Type S screws) spaced 8" o.c. at edges and 12" o.c. in the field.  One layer: 1-3/8" QuietRock® 545 gypsum panel applied vertically.  3-5/8" 33 mil steel studs, 16" o.c.  3-1/2", R-13 glass fiber insulation friction fit into stud cavity.  One layer: 1-3/8" QuietRock® 545 gypsum panel applied vertically.
Hz	TL							
80	29							
100	37							
<p align="center">Non-Load Bearing Vertical joints staggered on opposite sides</p>		<ul style="list-style-type: none">  1-7/8" Type S drywall screws (for fire, minimum 2" Type S screws) spaced 8" o.c. at edges and 12" o.c. in the field. 						



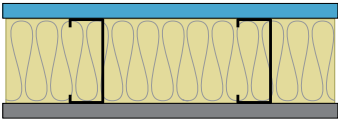
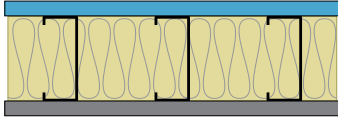





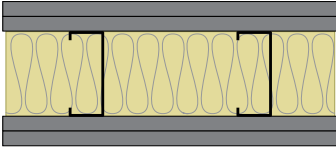
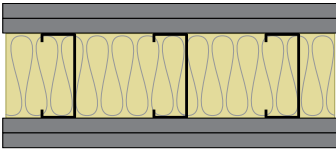

24" o.c.	16" o.c.	Description
	PGD-33-427-16	
	<p>STC 58 NOAL 18-0841 – 16" o.c.</p>  <p>Fire: 1 Hour - UL U425</p> <p>Thickness: 6" Approx weight: 8.2 lb/ft²</p>	<ul style="list-style-type: none">  1-5/8" Type S screws spaced 8" o.c. at edges and 12" o.c. in the field (for fire screws spaced 12" o.c.).  Face layer: 5/8" type X (FLAME CURB®, MOLD CURB® Plus, ABUSE CURB®, PABCO® Impact Resistant, PABCO® Glass Interior, PABCO® Glass Sheathing or PABCO® Gypsum Sheathing) gypsum panel applied vertically.  1" Type S screws spaced 8" o.c. at edges and 12" o.c. in the field (for fire screws spaced 12" o.c.).  Base layer: 5/8" type X (FLAME CURB®, MOLD CURB® Plus, ABUSE CURB®, PABCO® Impact Resistant, PABCO® Glass Interior, PABCO® Glass Sheathing or PABCO® Gypsum Sheathing) gypsum panel applied vertically.  3-5/8" 33 mil steel studs, 16" o.c.  3-1/2", R-13 glass fiber insulation friction fit into stud cavity.  Resilient channel applied at right-angle, 24" o.c.  1/2" Type S screws attaching resilient channel to stud at each intersection.  One layer: 5/8" QuietRock® ES or QuietRock® ES MR type X gypsum panel applied vertically.  1" Type S screws spaced 12" o.c.
<p>Load Bearing Vertical joints staggered on opposite sides</p>		







PGD-33-513-24	PGD-33-513-16	
<p>STC 53 NOAL 19-0710 – 24" o.c.</p>  <p>Fire: 1 Hour - UL V464 Configuration A</p> <p>Thickness: 4-7/8" Approx weight: 6.7 lb/ft²</p>	<p>STC 54 NOAL 18-0902 – 16" o.c.</p>  <p>Fire: 1 Hour - UL V464 Configuration A</p> <p>Thickness: 4-7/8" Approx weight: 6.7 lb/ft²</p>	<ul style="list-style-type: none">  1" Type S drywall screws spaced 8" at edges and 12" in the field (for fire, minimum 1-1/4" screws).  One layer: 5/8" QuietRock® 530 or QuietRock® 530 RF gypsum panel applied vertically.  3-5/8" 33 mil steel studs, 24" or 16" o.c.  3-1/2", R-13 glass fiber insulation friction fit into stud cavity.  One layer: 5/8" QuietRock® 530 or QuietRock® 530 RF gypsum panel applied vertically.  1" Type S drywall screws spaced 8" at edges and 12" in the field (for fire, minimum 1-1/4" screws).
<p>Non-Load Bearing Vertical joints staggered on opposite sides</p>		



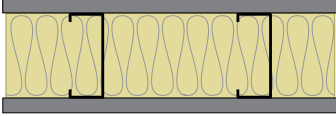
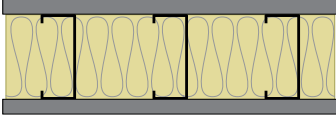





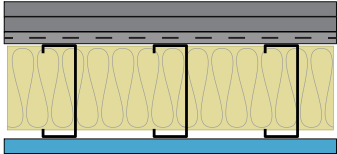

24" o.c.	16" o.c.	Description
<p>PGD-33-516-24</p> <p>STC 54 NOAL 18-0205 – 24" o.c.</p> <p>Fire: 1 Hour - UL U465</p> <p>Thickness: 5-1/2" Approx weight: 7.8 lb/ft²</p>		<ul style="list-style-type: none"> 1" Type S drywall screws spaced 8" at edges and 12" in the field. One layer: 5/8" QuietRock® ES or QuietRock® ES MR type X gypsum panel applied vertically. 3-5/8" 33 mil steel studs, 24" o.c. 3-1/2", R-13 glass fiber insulation friction fit into stud cavity. Base layer: 5/8" type X (FLAME CURB®, PABCO® Glass Interior, PABCO® Glass Sheathing) gypsum panel applied horizontally. 1" Type S drywall screws spaced 8" at edges and 12" in the field. Face layer: 5/8" type X (FLAME CURB®, PABCO® Glass Interior, PABCO® Glass Sheathing) gypsum panel applied horizontally. 2" Type S drywall screws (for fire, minimum 1-5/8" Type S drywall screws) spaced 12" in the field.
<p>Non-Load Bearing Vertical joints staggered on opposite sides</p>		









	<p>PGD-33-558-16</p> <p>STC 52 NOAL 21-0379 – 16" o.c.</p> <p>Fire: 1 Hour - UL U425</p> <p>Thickness: 5-3/8" Approx weight: 6.1 lb/ft²</p>	<ul style="list-style-type: none"> 1" Type S-12 drywall screws spaced 8" at edges and 12" in the field (for fire, screws spaced 12" o.c.). One layer: 5/8" QuietRock® ES or QuietRock® ES MR type X gypsum panel applied vertically. 3-5/8" 33 mil steel studs, 16" o.c. 3-1/2", R-13 glass fiber insulation friction fit into stud cavity. Resilient channel applied at right-angle, 24" o.c. 1/2" Type S-12 screws attaching resilient channel to stud at each intersection. One 5/8" type X (FLAME CURB®, MOLD CURB® Plus, ABUSE CURB®, PABCO® Impact Resistant, PABCO® Glass Interior, PABCO® Glass Sheathing or PABCO® Gypsum Sheathing) gypsum panel applied vertically. 1" Type S screws spaced 12" o.c.
<p>Load Bearing Vertical joints staggered on opposite sides</p>		

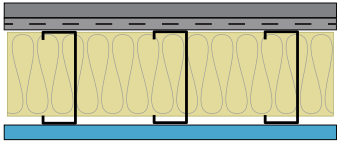







24" o.c.	16" o.c.	Description
<p style="text-align: center;">PGD-33-573-24</p> <p style="text-align: center;">STC 51 NOAL 18-0510 – 24" o.c.</p>  <p>Fire: 1 Hour - UL U425</p> <p>Thickness: 4-7/8" Approx weight: 5.6 lb/ft²</p>	<p style="text-align: center;">PGD-33-573-16</p> <p style="text-align: center;">STC 43 NOAL 21-0377 – 16" o.c.</p>  <p>Fire: 1 Hour - UL U425</p> <p>Thickness: 4-7/8" Approx weight: 5.9 lb/ft²</p>	<ul style="list-style-type: none">  1" Type S-12 drywall screws spaced 8" at edges and 12" in the field (for fire, screws spaced 12" o.c.).  One layer: 5/8" QuietRock® ES or QuietRock® ES MR type X gypsum panel applied vertically.  3-5/8" 33 mil steel studs, 24" o.c. or 16" o.c.  3-1/2", R-13 glass fiber insulation friction fit into stud cavity.  One 5/8" type X (FLAME CURB®, MOLD CURB® Plus, ABUSE CURB®, PABCO® Impact Resistant, PABCO® Glass Interior, PABCO® Glass Sheathing or PABCO® Gypsum Sheathing) gypsum panel applied vertically.
<p>Load Bearing Vertical joints staggered on opposite sides</p>		<ul style="list-style-type: none">  1" Type S-12 drywall screws spaced 8" at edges and 12" in the field (for fire, screws spaced 12" o.c.).

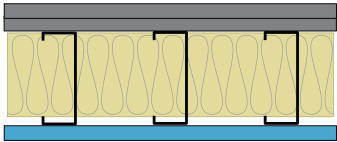





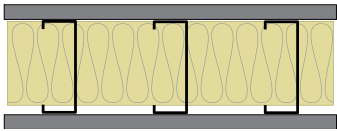

24" o.c.	16" o.c.	Description
<p style="text-align: center;">PGD-33-598-24</p> <p style="text-align: center;">STC 50 NOAL 19-0715 – 24" o.c.</p>  <p style="text-align: center;">Fire: 2 Hour - UL U425</p> <p>Thickness: 6-1/8" Approx weight: 9.3 lb/ft²</p>	<p style="text-align: center;">PGD-33-598-16</p> <p style="text-align: center;">STC 45 NOAL 21-0375 – 16" o.c.</p>  <p style="text-align: center;">Fire: 2 Hour - UL U425</p> <p>Thickness: 6-1/8" Approx weight: 9.5 lb/ft²</p>	<ul style="list-style-type: none">  1-5/8" Type S-12 drywall screws spaced 8" o.c. at edges and 12" o.c. in the field. (for fire, screws spaced 12" o.c.)  Face layer: 5/8" type X (FLAME CURB®, MOLD CURB® Plus, ABUSE CURB®, PABCO® Impact Resistant, PABCO® Glass Interior, PABCO® Glass Sheathing or PABCO® Gypsum Sheathing) gypsum panel applied vertically.  1-1/4" Type S-12 drywall screws spaced 8" o.c. at edges and 12" o.c. in the field. (for fire, minimum 1" S-12 drywall screws spaced 12" o.c.)  Base layer: 5/8" type X (FLAME CURB®, MOLD CURB® Plus, ABUSE CURB®, PABCO® Impact Resistant, PABCO® Glass Interior, PABCO® Glass Sheathing or PABCO® Gypsum Sheathing) gypsum panel applied vertically.  3-5/8" 33 mil steel studs, 24" o.c. or 16" o.c.  3-1/2", R-13 glass fiber insulation friction fit into stud cavity.  Base layer: 5/8" type X (FLAME CURB®, MOLD CURB® Plus, ABUSE CURB®, PABCO® Impact Resistant, PABCO® Glass Interior, PABCO® Glass Sheathing or PABCO® Gypsum Sheathing) gypsum panel applied vertically.  1-1/4" Type S drywall screws spaced 8" o.c. at edges and 12" o.c. in the field. (for fire, minimum 1" Type S-12 drywall screws spaced 12" o.c.)  Face layer: 5/8" type X (FLAME CURB®, MOLD CURB® Plus, ABUSE CURB®, PABCO® Impact Resistant, PABCO® Glass Interior, PABCO® Glass Sheathing or PABCO® Gypsum Sheathing) gypsum panel applied vertically.
<p>Load Bearing Vertical joints staggered on opposite sides</p>		<ul style="list-style-type: none">  1-5/8" Type S-12 drywall screws spaced 8" o.c. at edges and 12" o.c. in the field. (for fire, screws spaced 12" o.c.)

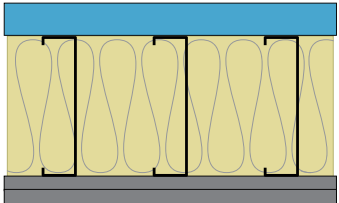







24" o.c.	16" o.c.	Description
<p>PGD-33-687-24</p> <p>STC 45 NOAL 19-0714 – 24" o.c.</p>  <p>Fire: 1 Hour - UL U425</p> <p>Thickness: 4-7/8" Approx weight: 5.1 lb/ft²</p>	<p>PGD-33-687-16</p> <p>STC 41 NOAL 18-0901 – 16" o.c.</p>  <p>Fire: 1 Hour - UL U425</p> <p>Thickness: 4-7/8" Approx weight: 5.4 lb/ft²</p>	<ul style="list-style-type: none">  1-1/4" Type S-12 drywall screws spaced 8" at edges and 12" in the field (for fire, minimum 1" Type S-12 drywall screws spaced 12" o.c.).  One layer: 5/8" type X ((FLAME CURB®, MOLD CURB® Plus, ABUSE CURB®, PABCO® Impact Resistant, PABCO® Glass Interior, PABCO® Glass Sheathing or PABCO® Gypsum Sheathing) gypsum panel applied vertically.  3-5/8" 33 mil steel studs, 24" o.c. or 16" o.c.  3-1/2", R-13 glass fiber insulation friction fit into stud cavity.  One layer: 5/8" type X (FLAME CURB®, MOLD CURB® Plus, ABUSE CURB®, PABCO® Impact Resistant, PABCO® Glass Interior, PABCO® Glass Sheathing or PABCO® Gypsum Sheathing) gypsum panel applied vertically.
<p>Load Bearing Vertical joints staggered on opposite sides</p>		<ul style="list-style-type: none">  1-1/4" Type S-12 drywall screws spaced 8" at edges and 12" in the field (for fire, minimum 1" Type S-12 drywall screws spaced 12" o.c.).

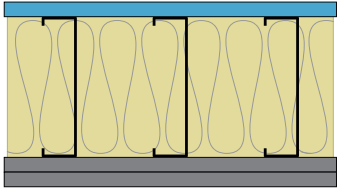







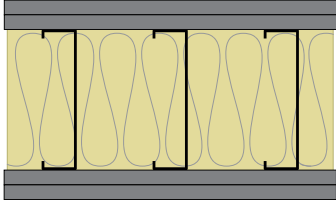

24" o.c.	16" o.c.	Description
	<p align="center">PGD-334-442-16</p> <p align="center">STC 57</p> <p align="center">NOAL 21-0391 – 16" o.c.</p>  <p align="center">Fire: 1 Hour - UL U425</p> <p align="center">Thickness: 6-3/8"</p> <p align="center">Approx weight: 8.2 lb/ft²</p>	<ul style="list-style-type: none">  1-5/8" Type S drywall screws spaced 12" o.c.  Face layer: 5/8" type X ((FLAME CURB®, MOLD CURB® Plus, ABUSE CURB®, PABCO® Impact Resistant, PABCO® Glass Interior, PABCO® Glass Sheathing or PABCO® Gypsum Sheathing) gypsum panel applied vertically.  1" Type S drywall screws spaced 12" o.c.  Base layer: 5/8" type X ((FLAME CURB®, MOLD CURB® Plus, ABUSE CURB®, PABCO® Impact Resistant, PABCO® Glass Interior, PABCO® Glass Sheathing or PABCO® Gypsum Sheathing) gypsum panel applied vertically.  Resilient channel applied at right-angle, 24" o.c.  4" 33 mil steel studs, 16" o.c.  3-1/2", R-13 glass fiber insulation friction fit into stud cavity.  One layer: 5/8" QuietRock® ES or QuietRock® ES MR type X gypsum panel applied vertically.
<p align="center">Load Bearing</p> <p align="center">Vertical joints staggered on opposite sides</p>		<ul style="list-style-type: none">  1" Type S-12 drywall screws spaced 8" at edges and 12" in the field (for fire, screws spaced 12" o.c.)







	<p align="center">PGD-334-572-16</p> <p align="center">STC 51</p> <p align="center">NOAL 21-0390 – 16" o.c.</p>  <p align="center">Fire: 1 Hour - UL U425</p> <p align="center">Thickness: 5-3/4"</p> <p align="center">Approx weight: 6.1 lb/ft²</p>	<ul style="list-style-type: none">  1" Type S drywall screws spaced 12" o.c.  One layer: 5/8" type X ((FLAME CURB®, MOLD CURB® Plus, ABUSE CURB®, PABCO® Impact Resistant, PABCO® Glass Interior, PABCO® Glass Sheathing or PABCO® Gypsum Sheathing) gypsum panel applied vertically.  Resilient channel applied at right-angle, 24" o.c.  4" 33 mil steel studs, 16" o.c.  3-1/2", R-13 glass fiber insulation friction fit into stud cavity.  One layer: 5/8" QuietRock® ES or QuietRock® ES MR type X gypsum panel applied vertically.
<p align="center">Load Bearing</p> <p align="center">Vertical joints staggered on opposite sides</p>		<ul style="list-style-type: none">  1" Type S-12 drywall screws spaced 8" at edges and 12" in the field (for fire, screws spaced 12" o.c.)



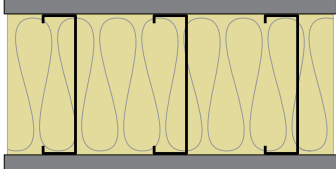





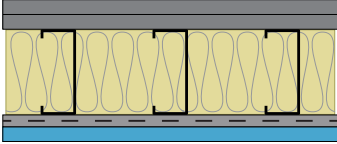

24" o.c.	16" o.c.	Description
<p style="text-align: center;">Load Bearing Vertical joints staggered on opposite sides</p>	<p style="text-align: center;">PGD-334-624-16</p> <p style="text-align: center;">STC 48 NOAL 21-0387 – 16" o.c.</p>  <p style="text-align: center;">Fire: 1 Hour - UL U425</p> <p style="text-align: center;">Thickness: 5-7/8" Approx weight: 8.1 lb/ft²</p>	<ul style="list-style-type: none">  1-5/8" Type S-12 drywall screws spaced 8" at edges and 12" in the field (for fire, screws spaced 12" o.c.).  Face layer: 5/8" type X ((FLAME CURB®, MOLD CURB® Plus, ABUSE CURB®, PABCO® Impact Resistant, PABCO® Glass Interior, PABCO® Glass Sheathing or PABCO® Gypsum Sheathing) gypsum panel applied vertically.  1" Type S-12 drywall screws spaced 8" at edges and 12" in the field (for fire, screws spaced 12" o.c.).  Base layer: 5/8" type X ((FLAME CURB®, MOLD CURB® Plus, ABUSE CURB®, PABCO® Impact Resistant, PABCO® Glass Interior, PABCO® Glass Sheathing or PABCO® Gypsum Sheathing) gypsum panel applied vertically.  4" 33 mil steel studs, 16" o.c.  3-1/2", R-13 glass fiber insulation friction fit into stud cavity.  One layer: 5/8" QuietRock® ES or QuietRock® ES MR type X gypsum panel applied vertically.  1" Type S-12 drywall screws spaced 8" at edges and 12" in the field (for fire, screws spaced 12" o.c.).
	<p style="text-align: center;">Load Bearing Vertical joints staggered on opposite sides</p>	<p style="text-align: center;">PGD-334-790-16</p> <p style="text-align: center;">STC 40 NOAL 21-0385 – 16" o.c.</p>  <p style="text-align: center;">Fire: 1 Hour - UL U425</p> <p style="text-align: center;">Thickness: 5-1/4" Approx weight: 5.4 lb/ft²</p>









24" o.c.	16" o.c.	Description						
	<p align="center">PGD-336-432-16</p> <p align="center">STC 58</p> <p align="center">NOAL 20-1235 – 16" o.c.</p> <p align="center">Low Frequency Transmission Loss</p> <table border="1" data-bbox="560 562 771 640"> <tr> <td>Hz</td> <td>TL</td> </tr> <tr> <td>80</td> <td>26</td> </tr> <tr> <td>100</td> <td>32</td> </tr> </table>  <p align="center">Fire: 1 Hour - UL U425</p> <p>Thickness: 8-5/8"</p> <p>Approx weight: 11.7 lb/ft²</p>	Hz	TL	80	26	100	32	<ul style="list-style-type: none">  2" Type S-12 drywall screws spaced 8" o.c. at edges and 12" o.c. in the field.  One layer: 1-3/8" QuietRock® 545 gypsum panel applied vertically.  6" 33 mil steel studs, 16" o.c.  6-1/2", R-19 glass fiber insulation friction fit into stud cavity.  Base layer: 5/8" type X (FLAME CURB®, MOLD CURB® Plus, ABUSE CURB®, PABCO® Impact Resistant, PABCO® Glass Interior, PABCO® Glass Sheathing or PABCO® Gypsum Sheathing) gypsum panel applied vertically.  1-1/4" Type S drywall screws spaced 8" o.c. at edges and 12" o.c. in the field. (for fire, minimum 1" Type S drywall screws spaced 12" o.c.)  Face layer: 5/8" type X (FLAME CURB®, MOLD CURB® Plus, ABUSE CURB®, PABCO® Impact Resistant, PABCO® Glass Interior, PABCO® Glass Sheathing or PABCO® Gypsum Sheathing) gypsum panel applied vertically.
Hz	TL							
80	26							
100	32							
<p align="center">Load Bearing</p> <p align="center">Vertical joints staggered on opposite sides</p>		<ul style="list-style-type: none">  1-5/8" Type S-12 drywall screws spaced 8" o.c. at edges and 12" o.c. in the field. (for fire, screws spaced 12" o.c.) 						

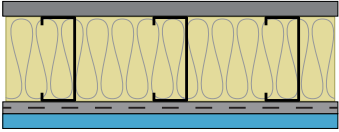







24" o.c.	16" o.c.	Description
	<p align="center">PGD-336-492-16</p> <p align="center">STC 50 NOAL 20-1228 – 16" o.c.</p>  <p align="center">Fire: 1 Hour - UL U425</p> <p>Thickness: 7-7/8" Approx weight: 8.3 lb/ft²</p>	<ul style="list-style-type: none">  1-1/4" Type S drywall screws spaced 8" at edges and 12" in the field (for fire, minimum 1" Type S-12 drywall screws spaced 12" o.c.).  One layer: 5/8" QuietRock® ES or QuietRock® ES MR type X gypsum panel applied vertically.  6" 33 mil steel studs, 16" o.c.  6", R-19 glass fiber insulation friction fit into stud cavity.  Base layer: 5/8" type X (FLAME CURB®, MOLD CURB® Plus, ABUSE CURB®, PABCO® Impact Resistant, PABCO® Glass Interior, PABCO® Glass Sheathing or PABCO® Gypsum Sheathing) gypsum panel applied vertically.  1-1/4" Type S drywall screws spaced 8" o.c. at edges and 12" o.c. in the field. (for fire, minimum 1" Type S-12 drywall screws spaced 12" o.c.)  Face layer: 5/8" type X (FLAME CURB®, MOLD CURB® Plus, ABUSE CURB®, PABCO® Impact Resistant, PABCO® Glass Interior, PABCO® Glass Sheathing or PABCO® Gypsum Sheathing) gypsum panel applied vertically.
<p align="center">Load Bearing Vertical joints staggered on opposite sides</p>		<ul style="list-style-type: none">  1-5/8" Type S-12 drywall screws spaced 8" o.c. at edges and 12" o.c. in the field. (for fire, screws spaced 12" o.c.)

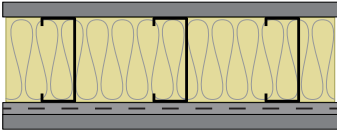







24" o.c.	16" o.c.	Description
	<p style="text-align: center;">PGD-336-687-16</p> <p style="text-align: center;">STC 45 NOAL 20-1222 – 16" o.c.</p>  <p style="text-align: center;">Fire: 2 Hour - UL U425</p> <p>Thickness: 8-1/2 Approx weight: 9.9 lb/ft²</p>	<ul style="list-style-type: none">  1-5/8" Type S-12 drywall screws spaced 8" o.c. at edges and 12" o.c. in the field. (for fire, screws spaced 12" o.c.)  Face layer: 5/8" type X (FLAME CURB®, MOLD CURB® Plus, ABUSE CURB®, PABCO® Impact Resistant, PABCO® Glass Interior, PABCO® Glass Sheathing or PABCO® Gypsum Sheathing) gypsum panel applied vertically.  1-1/4" Type S-12 drywall screws spaced 8" o.c. at edges and 12" o.c. in the field, minimum 1" Type S-12 drywall screws spaced 12" o.c.)  Base layer: 5/8" type X (FLAME CURB®, MOLD CURB® Plus, ABUSE CURB®, PABCO® Impact Resistant, PABCO® Glass Interior, PABCO® Glass Sheathing or PABCO® Gypsum Sheathing) gypsum panel applied vertically.  6" 33 mil steel studs, 16" o.c.  6-1/2", R-19 glass fiber insulation friction fit into stud cavity.  Base layer: 5/8" type X (FLAME CURB®, MOLD CURB® Plus, ABUSE CURB®, PABCO® Impact Resistant, PABCO® Glass Interior, PABCO® Glass Sheathing or PABCO® Gypsum Sheathing) gypsum panel applied vertically.  1-1/4" Type S-12 drywall screws spaced 8" o.c. at edges and 12" o.c. in the field, minimum 1" Type S-12 drywall screws spaced 12" o.c.)  Face layer: 5/8" type X (FLAME CURB®, MOLD CURB® Plus, ABUSE CURB®, PABCO® Impact Resistant, PABCO® Glass Interior, PABCO® Glass Sheathing or PABCO® Gypsum Sheathing) gypsum panel applied vertically.
<p>Limited Load Bearing Vertical joints staggered on opposite sides</p>		<ul style="list-style-type: none">  1-5/8" Type S-12 drywall screws spaced 8" o.c. at edges and 12" o.c. in the field. (for fire, screws spaced 12" o.c.)

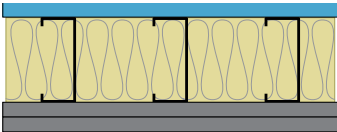









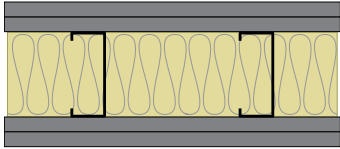
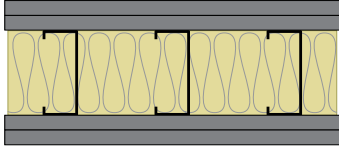





24" o.c.	16" o.c.	Description
	<p align="center">PGD-336-757-16</p> <p align="center">STC 42 NOAL 20-1221 – 16" o.c.</p>  <p align="center">Fire: 1 Hour - UL U425</p> <p align="center">Thickness: 7-1/4" Approx weight: 5.7 lb/ft²</p>	<ul style="list-style-type: none">  1-1/4" Type S-12 drywall screws spaced 8" at edges and 12" in the field (for fire, minimum 1" Type S-12 drywall screws spaced 12" o.c.).  One layer: 5/8" type X ((FLAME CURB®, MOLD CURB® Plus, ABUSE CURB®, PABCO® Impact Resistant, PABCO® Glass Interior, PABCO® Glass Sheathing or PABCO® Gypsum Sheathing) gypsum panel applied vertically.  6" 33 mil steel studs, 16" o.c.  6-1/2", R-19 glass fiber insulation friction fit into stud cavity.  One layer: 5/8" type X (FLAME CURB®, MOLD CURB® Plus, ABUSE CURB®, PABCO® Impact Resistant, PABCO® Glass Interior, PABCO® Glass Sheathing or PABCO® Gypsum Sheathing) gypsum panel applied vertically.
<p align="center">Load Bearing Vertical joints staggered on opposite sides</p>		<ul style="list-style-type: none">  1-1/4" Type S-12 drywall screws spaced 8" at edges and 12" in the field (for fire, minimum 1" Type S-12 drywall screws spaced 12" o.c.).



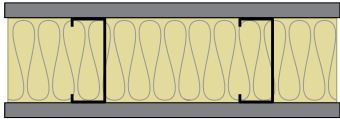
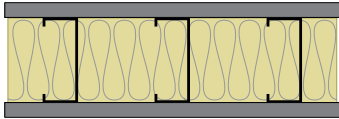



24" o.c.	16" o.c.	Description
	<p data-bbox="578 348 756 375">PGD-43-394-16</p> <p data-bbox="610 590 724 625">STC 57</p> <p data-bbox="553 632 781 659">NOAL 18-0748 – 16" o.c.</p>  <p data-bbox="513 932 729 959">Fire: 1 Hour - UL U425</p> <p data-bbox="513 999 751 1058">Thickness: 6" Approx weight: 8.5 lb/ft²</p>	<ul style="list-style-type: none"> <li data-bbox="873 380 1495 428"> 1-5/8" Type S-12 drywall screws spaced 8" o.c. at edges and 12" o.c. in the field. (for fire, screws spaced 12" o.c.) <li data-bbox="873 464 1479 548"> Face layer: 5/8" type X (FLAME CURB®, MOLD CURB® Plus, ABUSE CURB®, PABCO® Impact Resistant, PABCO® Glass Interior, PABCO® Glass Sheathing or PABCO® Gypsum Sheathing) gypsum panel applied vertically. <li data-bbox="873 569 1495 638"> 1-1/4" Type S-12 drywall screws spaced 8" at edges and 12" in the field (for fire, minimum 1" Type S-12 drywall screws spaced 12" o.c.). <li data-bbox="873 659 1479 743"> Base layer: 5/8" type X (FLAME CURB®, MOLD CURB® Plus, ABUSE CURB®, PABCO® Impact Resistant, PABCO® Glass Interior, PABCO® Glass Sheathing or PABCO® Gypsum Sheathing) gypsum panel applied vertically. <li data-bbox="873 779 1243 827"> 3-5/8" 43 mil steel studs, 16" o.c. <li data-bbox="873 890 1495 938"> 3-1/2", R-13 glass fiber insulation friction fit into stud cavity. <li data-bbox="873 995 1390 1043"> Resilient channel applied at right-angle, 24" o.c. <li data-bbox="873 1100 1495 1148"> 1/2" Type S-12 screws attaching resilient channel to stud at each intersection. <li data-bbox="873 1184 1479 1253"> One layer: 5/8" QuietRock® ES or QuietRock® ES MR type X gypsum panel applied vertically.
<p data-bbox="289 1283 688 1346">Load Bearing Vertical joints staggered on opposite sides</p>		<ul style="list-style-type: none"> <li data-bbox="873 1283 1422 1331"> 1" Type S drywall screws spaced 12" o.c. in the field.



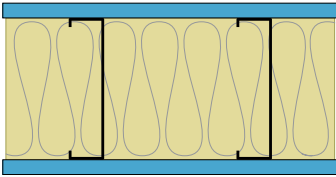
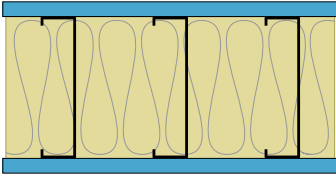





24" o.c.	16" o.c.	Description
	<p align="center">PGD-43-476-16</p> <p align="center">STC 51 NOAL 18-0747 – 16" o.c.</p>  <p align="center">Fire: 1 Hour - UL U425</p> <p align="center">Thickness: 5-3/8" Approx weight: 6.3 lb/ft²</p>	<ul style="list-style-type: none">  1-1/4" Type S-12 drywall screws 8" o.c. at edges and 12" o.c. in the field (for fire, minimum 1" Type S-12 drywall screws spaced 12" o.c.).  One layer: 5/8" type X (FLAME CURB®, MOLD CURB® Plus, ABUSE CURB®, PABCO® Impact Resistant, PABCO® Glass Interior, PABCO® Glass Sheathing or PABCO® Gypsum Sheathing) gypsum panel applied vertically.  3-5/8" 43 mil steel studs, 16" o.c.  3-1/2", R-13 glass fiber insulation friction fit into stud cavity.  Resilient channel applied at right-angle, 24" o.c.  1/2" Type S-12 screws attaching resilient channel to stud at each intersection.  One layer: 5/8" QuietRock® ES or QuietRock® ES MR type X gypsum panel applied vertically.
<p align="center">Load Bearing Vertical joints staggered on opposite sides</p>		<ul style="list-style-type: none">  1" Type S drywall screws spaced 8" o.c. at edges and 12" o.c.

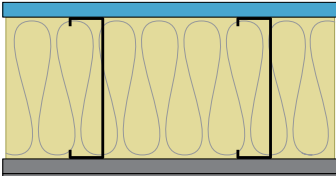





24" o.c.	16" o.c.	Description
	<p align="center">PGD-43-584-16</p> <p align="center">STC 47 NOAL 18-0740 – 16" o.c.</p>  <p align="center">Fire: 1 Hour - UL U425</p> <p align="center">Thickness: 5-3/8" Approx weight: 5.8 lb/ft²</p>	<ul style="list-style-type: none">  1-1/4" Type S-12 drywall screws 8" o.c. at edges and 12" o.c. in the field (for fire, minimum 1" Type S-12 drywall screws spaced 12" o.c.).  One layer: 5/8" type X (FLAME CURB®, MOLD CURB® Plus, ABUSE CURB®, PABCO® Impact Resistant, PABCO® Glass Interior, PABCO® Glass Sheathing or PABCO® Gypsum Sheathing)) gypsum panel applied vertically.  3-5/8" 43 mil steel studs, 16" o.c.  3-1/2", R-13 glass fiber insulation friction fit into stud cavity.  Resilient channel applied at right-angle, 24" o.c.  1/2" Type S-12 screws attaching resilient channel to stud at each intersection.  One layer: 5/8" type X (FLAME CURB®, MOLD CURB® Plus, ABUSE CURB®, PABCO® Impact Resistant, PABCO® Glass Interior, PABCO® Glass Sheathing or PABCO® Gypsum Sheathing)) gypsum panel applied vertically.
<p>Load Bearing Vertical joints staggered on opposite sides</p>		<ul style="list-style-type: none">  1" Type S drywall screws spaced 12" o.c.



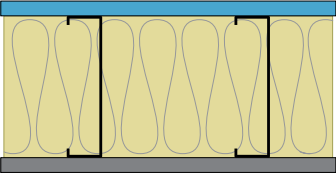







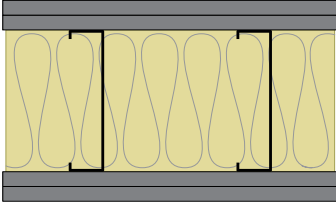





	<p align="center">PGD-43-595-16</p> <p align="center">STC 45 NOAL 18-0735 – 16" o.c.</p>  <p align="center">Fire: 1 Hour - UL U425</p> <p align="center">Thickness: 5-1/2" Approx weight: 8.3 lb/ft²</p>	<ul style="list-style-type: none">  1-1/4" Type S-12 drywall screws spaced 8" o.c. at edges and 12" o.c. in the field (for fire, minimum 1" Type S-12 drywall screws spaced 12" o.c.).  One layer: 5/8" QuietRock® ES or QuietRock® ES MR type X gypsum panel applied vertically.  3-5/8" 43 mil steel studs, 16" o.c.  3-1/2", R-13 glass fiber insulation friction fit into stud cavity.  Base layer: 5/8" type X (FLAME CURB®, MOLD CURB® Plus, ABUSE CURB®, PABCO® Impact Resistant, PABCO® Glass Interior, PABCO® Glass Sheathing or PABCO® Gypsum Sheathing)) gypsum panel applied vertically.  1-1/4" Type S-12 drywall screws spaced 8" o.c. at edges and 12" o.c. in the field (for fire, minimum 1" Type S-12 drywall screws spaced 12" o.c.).  Face layer: 5/8" type X (FLAME CURB®, MOLD CURB® Plus, ABUSE CURB®, PABCO® Impact Resistant, PABCO® Glass Interior, PABCO® Glass Sheathing or PABCO® Gypsum Sheathing)) gypsum panel applied vertically.
<p>Load Bearing Vertical joints staggered on opposite sides</p>		<ul style="list-style-type: none">  1-5/8" Type S-12 drywall screws spaced 8" o.c. at edges and 12" o.c. in the field (for fire screws spaced 12" o.c.).



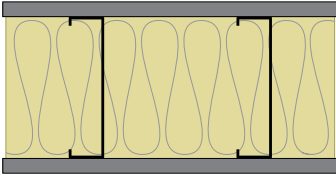



24" o.c.	16" o.c.	Description
<p style="text-align: center;">PGD-43-604-24</p> <p style="text-align: center;">STC 49 NOAL 19-0733 – 24" o.c.</p>  <p>Fire: 2 Hour - UL U425</p> <p>Thickness: 6-1/8" Approx weight: 9.7 lb/ft²</p>	<p style="text-align: center;">PGD-43-604-16</p> <p style="text-align: center;">STC 42 NOAL 18-0737 – 16" o.c.</p>  <p>Fire: 2 Hour - UL U425</p> <p>Thickness: 6-1/8" Approx weight: 9.9 lb/ft²</p>	<ul style="list-style-type: none">  1-5/8" Type S-12 drywall screws spaced 8" o.c. at edges and 12" o.c. in the field (for fire, screws spaced 12" o.c.).  Face layer: 5/8" type X (FLAME CURB®, MOLD CURB® Plus, ABUSE CURB®, PABCO® Impact Resistant, PABCO® Glass Interior, PABCO® Glass Sheathing or PABCO® Gypsum Sheathing) gypsum panel applied vertically.  1-1/4" Type S-12 drywall screws spaced 8" o.c. at edges and 12" o.c. in the field (for fire, minimum 1" Type S-12 drywall screws spaced 12" o.c.).  Base layer: 5/8" type X (FLAME CURB®, MOLD CURB® Plus, ABUSE CURB®, PABCO® Impact Resistant, PABCO® Glass Interior, PABCO® Glass Sheathing or PABCO® Gypsum Sheathing) gypsum panel applied vertically.  3-5/8" 43 mil steel studs, 24" o.c. or 16" o.c.  3-1/2", R-13 glass fiber insulation friction fit into stud cavity.  Base layer: 5/8" type X (FLAME CURB®, MOLD CURB® Plus, ABUSE CURB®, PABCO® Impact Resistant, PABCO® Glass Interior, PABCO® Glass Sheathing or PABCO® Gypsum Sheathing) gypsum panel applied vertically.  1-1/4" Type S-12 drywall screws spaced 8" o.c. at edges and 12" o.c. in the field (for fire, minimum 1" Type S-12 drywall screws spaced 12" o.c.).  Face layer: 5/8" type X (FLAME CURB®, MOLD CURB® Plus, ABUSE CURB®, PABCO® Impact Resistant, PABCO® Glass Interior, PABCO® Glass Sheathing or PABCO® Gypsum Sheathing) gypsum panel applied vertically.
<p>Limited Load Bearing Vertical joints staggered on opposite sides</p>		<ul style="list-style-type: none">  1-5/8" Type S-12 drywall screws spaced 8" o.c. at edges and 12" o.c. in the field (for fire, screws spaced 12" o.c.).
<p style="text-align: center;">PGD-43-824-24</p> <p style="text-align: center;">STC 43 NOAL 19-0732 – 24" o.c.</p>  <p>Fire: 1 Hour - UL U425</p> <p>Thickness: 4-7/8" Approx weight: 5.5 lb/ft²</p>	<p style="text-align: center;">PGD-43-824-16</p> <p style="text-align: center;">STC 38 NOAL 18-0739 – 16" o.c.</p>  <p>Fire: 1 Hour - UL U425</p> <p>Thickness: 4-7/8" Approx weight: 5.7 lb/ft²</p>	<ul style="list-style-type: none">  1-1/4" Type S-12 drywall screws spaced 8" o.c. at edges and 12" o.c. in the field (for fire, minimum 1" Type S-12 screws spaced 12" o.c.).  One layer: 5/8" type X (FLAME CURB®, MOLD CURB® Plus, ABUSE CURB®, PABCO® Impact Resistant, PABCO® Glass Interior, PABCO® Glass Sheathing or PABCO® Gypsum Sheathing) gypsum panel applied vertically.  3-5/8" 43 mil steel studs, 24" o.c. or 16" o.c.  3-1/2", R-13 glass fiber insulation friction fit into stud cavity.  One layer: 5/8" type X (FLAME CURB®, MOLD CURB® Plus, ABUSE CURB®, PABCO® Impact Resistant, PABCO® Glass Interior, PABCO® Glass Sheathing or PABCO® Gypsum Sheathing) gypsum panel applied vertically.
<p>Load Bearing Vertical joints staggered on opposite sides</p>		<ul style="list-style-type: none">  1-1/4" Type S-12 drywall screws spaced 8" o.c. at edges and 12" o.c. in the field (for fire, minimum 1" Type S-12 screws spaced 12" o.c.).



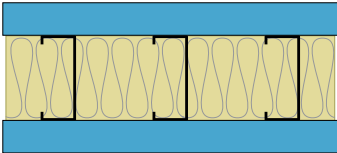





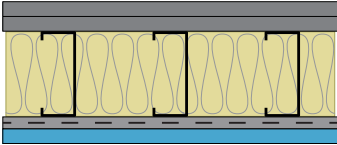

24" o.c.	16" o.c.	Description
<p>PGD-436-485-24</p> <p>STC 55 NOAL 18-1024 – 24" o.c.</p>  <p>Fire: 1 Hour - UL U425</p> <p>Thickness: 7-1/4" Approx weight: 6.8 lb/ft²</p>	<p>PGD-436-485-16</p> <p>STC 46 NOAL 18-1021 – 16" o.c.</p>  <p>Fire: 1 Hour - UL U425</p> <p>Thickness: 7-1/4" Approx weight: 7.2 lb/ft²</p>	<ul style="list-style-type: none">  1" Type S-12 drywall screws 12" o.c.  One layer: 5/8" QuietRock® ES or QuietRock® ES MR type X gypsum panel applied vertically.  6" 43 mil steel studs, 24" o.c. or 16" o.c.  6-1/2", R-19 glass fiber insulation friction fit into stud cavity  One layer: 5/8" QuietRock® ES or QuietRock® ES MR type X gypsum panel applied vertically.  1" Type S-12 drywall screws 12" o.c.
<p>Load Bearing Vertical joints staggered on opposite sides</p>		







<p>PGD-436-517-24</p> <p>STC 54 NOAL 18-1025 – 24" o.c.</p>  <p>Fire: 1 Hour - UL U425</p> <p>Thickness: 7-7/8" Approx weight: 8.4 lb/ft²</p>		<ul style="list-style-type: none">  1" Type S-12 drywall screws 12" o.c.  One layer: 5/8" QuietRock® ES or QuietRock® ES MR type X gypsum panel applied vertically.  6" 43 mil steel studs, 24" o.c.  6-1/2", R-19 glass fiber insulation friction fit into stud cavity  Base layer: 5/8" Type X (FLAME CURB®, MOLD CURB® Plus, ABUSE CURB®, PABCO® Impact Resistant, PABCO® Glass Interior, PABCO® Glass Sheathing or PABCO® Gypsum Sheathing) gypsum panel applied vertically.  1" Type S-12 drywall screws 12" o.c. in the field.  Face layer: 5/8" Type X (FLAME CURB®, MOLD CURB® Plus, ABUSE CURB®, PABCO® Impact Resistant, PABCO® Glass Interior, PABCO® Glass Sheathing or PABCO® Gypsum Sheathing) gypsum panel applied vertically.  1-5/8" Type S-12 drywall screws 12" o.c.
<p>Load Bearing Vertical joints staggered on opposite sides</p>		



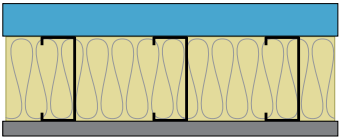



24" o.c.	16" o.c.	Description
<p>PGD-436-592-24</p> <p>STC 50 NOAL 18-1023 – 24" o.c.</p>  <p>Fire: 1 Hour - UL U425</p> <p>Thickness: 7-1/4" Approx weight: 6.2 lb/ft²</p>		<ul style="list-style-type: none">  1" Type S-12 drywall screws 12" o.c.  One layer: 5/8" QuietRock® ES or QuietRock® ES MR type X gypsum panel applied vertically.  6" 43 mil steel studs, 24" o.c.  3-1/2", R-13 glass fiber insulation friction fit into stud cavity  One layer: 5/8" Type X (FLAME CURB®, MOLD CURB® Plus, ABUSE CURB®, PABCO® Impact Resistant, PABCO® Glass Interior, PABCO® Glass Sheathing or PABCO® Gypsum Sheathing) gypsum panel applied vertically.
<p>Load Bearing Vertical joints staggered on opposite sides</p>		<ul style="list-style-type: none">  1" Type S-12 drywall screws 12" o.c.



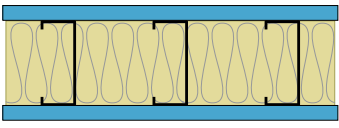





24" o.c.	16" o.c.	Description
<p>PGD-436-598-24</p> <p>STC 50 NOAL 18-1028 – 24" o.c.</p>  <p>Fire: 2 Hour - UL U425</p> <p>Thickness: 8-1/2" Approx weight: 9.8 lb/ft²</p>		<ul style="list-style-type: none">  1-5/8" Type S-12 drywall screws 12" o.c.  Face layer: 5/8" type X (FLAME CURB®, MOLD CURB® Plus, ABUSE CURB®, PABCO® Impact Resistant, PABCO® Glass Interior, PABCO® Glass Sheathing or PABCO® Gypsum Sheathing) gypsum panel applied vertically.  1" Type S-12 drywall screws 12" o.c.  Base layer: 5/8" type X (FLAME CURB®, MOLD CURB® Plus, ABUSE CURB®, PABCO® Impact Resistant, PABCO® Glass Interior, PABCO® Glass Sheathing or PABCO® Gypsum Sheathing) gypsum panel applied vertically.  6" 43 mil steel studs, 24" o.c.  6-1/2", R-19 glass fiber insulation friction fit into stud cavity.  Base layer: 5/8" type X (FLAME CURB®, MOLD CURB® Plus, ABUSE CURB®, PABCO® Impact Resistant, PABCO® Glass Interior, PABCO® Glass Sheathing or PABCO® Gypsum Sheathing) gypsum panel applied vertically.  1" Type S-12 drywall screws 12" o.c.  Face layer: 5/8" type X (FLAME CURB®, MOLD CURB® Plus, ABUSE CURB®, PABCO® Impact Resistant, PABCO® Glass Interior, PABCO® Glass Sheathing or PABCO® Gypsum Sheathing) gypsum panel applied vertically.
<p>Load Bearing Vertical joints staggered on opposite sides</p>		<ul style="list-style-type: none">  1-5/8" Type S-12 drywall screws 12" o.c.
<p>PGD-436-716-24</p> <p>STC 44 NOAL 18-1031 – 24" o.c.</p>  <p>Fire: 1 Hour - UL U425</p> <p>Thickness: 7-1/4" Approx weight: 5.6 lb/ft²</p>		<ul style="list-style-type: none">  1" Type S-12 drywall screws 12" o.c.  One layer: 5/8" Type X (FLAME CURB®, MOLD CURB® Plus, ABUSE CURB®, PABCO® Impact Resistant, PABCO® Glass Interior, PABCO® Glass Sheathing or PABCO® Gypsum Sheathing) gypsum panel applied vertically.  6" 43 mil steel studs, 24" o.c.  6-1/2", R-19 glass fiber insulation friction fit into stud cavity  One layer: 5/8" Type X (FLAME CURB®, MOLD CURB® Plus, ABUSE CURB®, PABCO® Impact Resistant, PABCO® Glass Interior, PABCO® Glass Sheathing or PABCO® Gypsum Sheathing) gypsum panel applied vertically.
<p>Load Bearing Vertical joints staggered on opposite sides</p>		<ul style="list-style-type: none">  1" Type S-12 drywall screws 12" o.c.

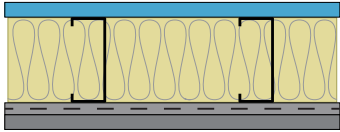
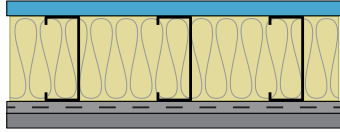





24" o.c.	16" o.c.	Description						
	<p align="center">PGD-54-314-16</p> <p align="center">STC 60</p> <p align="center">NOAL 18-0910 – 16" o.c.</p> <p align="center">Low Frequency Transmission Loss</p> <table border="0"> <tr> <td align="center">Hz</td> <td align="center">TL</td> </tr> <tr> <td align="center">80</td> <td align="center">22</td> </tr> <tr> <td align="center">100</td> <td align="center">31</td> </tr> </table>  <p align="center">Fire: 2 Hour - UL W466</p> <p align="center">Thickness: 6-3/8"</p> <p align="center">Approx weight: 13.4 lb/ft²</p>	Hz	TL	80	22	100	31	<ul style="list-style-type: none">  1-7/8" Type S drywall screws (for fire, minimum 2" Type S screws) spaced 8" o.c. at edges and 12" o.c. in the field.  One layer: 1-3/8" QuietRock® 545 gypsum panel applied vertically.  3-5/8" 54 mil steel studs, 16" o.c.  3-1/2", R-13 glass fiber insulation friction fit into stud cavity.  One layer: 1-3/8" QuietRock® 545 gypsum panel applied vertically.
Hz	TL							
80	22							
100	31							
<p align="center">Load Bearing</p> <p align="center">Vertical joints staggered on opposite sides</p>		<ul style="list-style-type: none">  1-7/8" Type S drywall screws (for fire, minimum 2" Type S screws) spaced 8" o.c. at edges and 12" o.c. in the field. 						



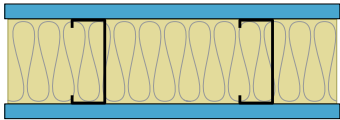
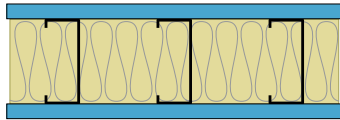





24" o.c.	16" o.c.	Description
	<p align="center">PGD-54-406-16</p> <p align="center">STC 56 NOAL 21-0349 – 16" o.c.</p>  <p align="center">Fire: 1 Hour - UL U425</p> <p align="center">Thickness: 6" Approx weight: 8.7 lb/ft²</p>	<ul style="list-style-type: none">  1-5/8" Type S-12 drywall screws spaced 12" o.c. in the field  Face layer: 5/8" type X (FLAME CURB®, MOLD CURB® Plus, ABUSE CURB®, PABCO® Impact Resistant, PABCO® Glass Interior, PABCO® Glass Sheathing or PABCO® Gypsum Sheathing) gypsum panel applied vertically.  1" Type S-12 drywall screws spaced 12" o.c. in the field  Base layer: 5/8" type X (FLAME CURB®, MOLD CURB® Plus, ABUSE CURB®, PABCO® Impact Resistant, PABCO® Glass Interior, PABCO® Glass Sheathing or PABCO® Gypsum Sheathing) gypsum panel applied vertically.  Resilient channel applied at right-angle, 24" o.c.  1/2" Type S-12 screws attaching resilient channel to stud at each intersection.  3-5/8" 54 mil steel studs, 16" o.c.  3-1/2", R-13 glass fiber insulation friction fit into stud cavity.  One layer: 5/8" QuietRock® ES or QuietRock® ES MR type X gypsum panel applied vertically.
<p align="center">Load Bearing Vertical joints staggered on opposite sides</p>		<ul style="list-style-type: none">  1" Type S drywall screws spaced 8" o.c. at edges and 12" o.c. in the field

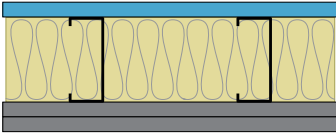
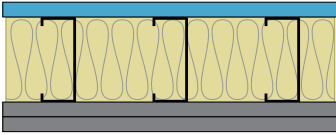







24" o.c.	16" o.c.	Description						
	<p>PGD-54-516-16</p> <p>STC 52 NOAL 18-0909 – 16" o.c.</p> <p>Low Frequency Transmission Loss</p> <table border="1"> <tr> <td>Hz</td> <td>TL</td> </tr> <tr> <td>80</td> <td>22</td> </tr> <tr> <td>100</td> <td>31</td> </tr> </table>  <p>Fire: 1 Hour - UL U425</p> <p>Thickness: 5-5/8" Approx weight: 9.6 lb/ft²</p>	Hz	TL	80	22	100	31	<ul style="list-style-type: none">  1-7/8" Type S-12 drywall screws spaced 8" o.c. at edges and 12" o.c. in the field (for fire, minimum 2" screws).  One layer: 1-3/8" QuietRock® 545 gypsum panel applied vertically.  3-5/8" 54 mil steel studs, 16" o.c.  3-1/2", R-13 glass fiber insulation friction fit into stud cavity.  One layer: 5/8" type X (FLAME CURB®, MOLD CURB® Plus, ABUSE CURB®, PABCO® Impact Resistant, PABCO® Glass Interior, PABCO® Glass Sheathing or PABCO® Gypsum Sheathing) gypsum panel applied vertically.  1-1/4" Type S-12 drywall screws 8" o.c. at edges and 12" o.c. in the field (for fire, minimum 1" Type S-12 drywall screws spaced 12" o.c.).
Hz	TL							
80	22							
100	31							
<p>Load Bearing Vertical joints staggered on opposite sides</p>								

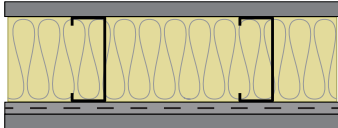
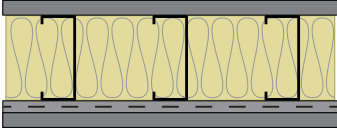





	<p>PGD-54-526-16</p> <p>STC 51 NOAL 18-0911 – 16" o.c.</p>  <p>Fire: 1 Hour - UL U425</p> <p>Thickness: 4-7/8" Approx weight: 7.2 lb/ft²</p>	<ul style="list-style-type: none">  1" Type S-12 drywall screws spaced 8" o.c. at edges and 12" o.c. in the field. (for fire, minimum 1" screws spaced 12" o.c.)  One layer: 5/8" QuietRock® 530 or QuietRock® 530 RF gypsum panel applied vertically.  3-5/8" 54 mil steel studs, 16" o.c.  3-1/2", R-13 glass fiber insulation friction fit into stud cavity.  One layer: 5/8" QuietRock® 530 or QuietRock® 530 RF gypsum panel applied vertically.  1" Type S-12 drywall screws spaced 8" o.c. at edges and 12" o.c. in the field
<p>Load Bearing Vertical joints staggered on opposite sides</p>		



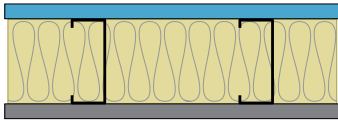
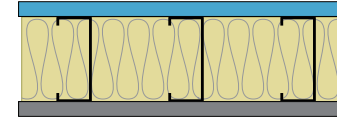







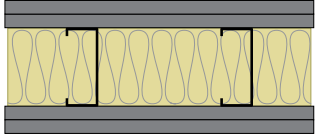
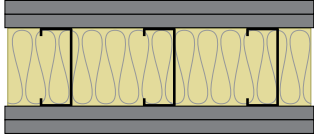





24" o.c.	16" o.c.	Description
<p>PGD-54-552-24</p> <p>STC 52 NOAL 19-0724 – 24" o.c.</p>  <p>Fire: 1 Hour - UL U425</p> <p>Thickness: 5-3/8" Approx weight: 6.3 lb/ft²</p>	<p>PGD-54-552-16</p> <p>STC 52 NOAL 21-0348 – 16" o.c.</p>  <p>Fire: 1 Hour - UL U425</p> <p>Thickness: 5-3/8" Approx weight: 6.6 lb/ft²</p>	<ul style="list-style-type: none">  1" Type S-12 drywall screws spaced 8" o.c. at edges and 12" o.c. in the field. (For fire, screws spaced 12" o.c.)  One layer: 5/8" QuietRock® ES or QuietRock® ES MR type X gypsum panel applied vertically.  3-5/8" 54 mil steel studs, 24" o.c. or 16" o.c.  3-1/2", R-13 glass fiber insulation friction fit into stud cavity.  Resilient channel applied at right-angle, 24" o.c.  1/2" Type S-12 screws attaching resilient channel to stud at each intersection.  One layer: 5/8" type X (FLAME CURB®, MOLD CURB® Plus, ABUSE CURB®, PABCO® Impact Resistant, PABCO® Glass Interior, PABCO® Glass Sheathing or PABCO® Gypsum Sheathing) gypsum panel applied vertically.  1" Type S drywall screws spaced and 12" o.c.
<p>Load Bearing Vertical joints staggered on opposite sides</p>		



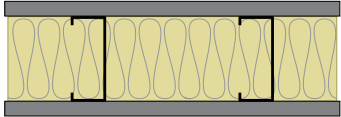
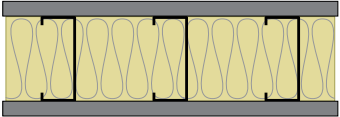



<p>PGD-54-554-24</p> <p>STC 52 NOAL 19-0722 – 24" o.c.</p>  <p>Fire: 1 Hour - UL U425</p> <p>Thickness: 4-7/8" Approx weight: 6.8 lb/ft²</p>	<p>PGD-54-554-16</p> <p>STC 45 NOAL 18-0912 – 16" o.c.</p>  <p>Fire: 1 Hour - UL U425</p> <p>Thickness: 4-7/8" Approx weight: 7.1 lb/ft²</p>	<ul style="list-style-type: none">  1-1/4" Type S-12 drywall screws 8" o.c. at edges and 12" o.c. in the field. (For fire, minimum 1" screws spaced 12" o.c.)  One layer: 5/8" QuietRock® ES or QuietRock® ES MR Type X gypsum panel applied vertically.  3-5/8" 54 mil steel studs, 24" o.c. or 16" o.c.  3-1/2", R-13 glass fiber insulation friction fit into stud cavity.  One layer: 5/8" QuietRock® ES or QuietRock® ES MR type X gypsum panel applied vertically.  1-1/4" Type S-12 drywall screws 8" o.c. at edges and 12" o.c. in the field. (For fire, minimum 1" screws spaced 12" o.c.)
<p>Load Bearing Vertical joints staggered on opposite sides</p>		



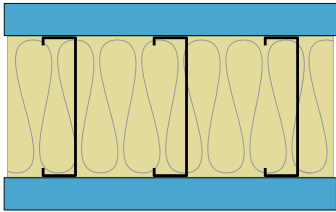





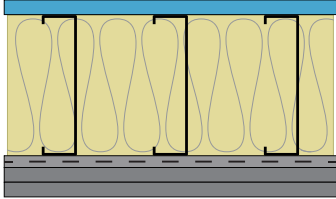

24" o.c.	16" o.c.	Description
<p align="center">PGD-54-556-24</p> <p align="center">STC 52 NOAL 19-1026 – 24" o.c.</p>  <p>Fire: 1 Hour - UL U425</p> <p>Thickness: 5-1/2" Approx weight: 8.2 lb/ft²</p>	<p align="center">PGD-54-556-16</p> <p align="center">STC 45 NOAL 18-0626 – 16" o.c.</p>  <p>Fire: 1 Hour - UL U425</p> <p>Thickness: 5-1/2" Approx weight: 8.4 lb/ft²</p>	<ul style="list-style-type: none">  1-1/4" Type S drywall screws spaced 8" o.c. at edges and 12" o.c. in the field. (For fire, minimum 1" screws spaced 12" o.c.)  One layer: 5/8" QuietRock® ES or QuietRock® ES MR type X gypsum panel applied vertically.  3-5/8" 54 mil steel studs, 24" o.c. or 16" o.c.  3-1/2", R-13 glass fiber insulation friction fit into stud cavity.  Base layer: type X (FLAME CURB®, MOLD CURB® Plus, ABUSE CURB®, PABCO® Impact Resistant, PABCO® Glass Interior, PABCO® Glass Sheathing or PABCO® Gypsum Sheathing) gypsum panel applied vertically.  1-1/4" Type S drywall screws spaced 8" o.c. at edges and 12" o.c. in the field. (For fire, minimum 1" screws spaced 12" o.c.)  Face layer: 5/8" type X (FLAME CURB®, MOLD CURB® Plus, ABUSE CURB®, PABCO® Impact Resistant, PABCO® Glass Interior, PABCO® Glass Sheathing or PABCO® Gypsum Sheathing) gypsum panel applied vertically.
<p>Load Bearing Vertical joints staggered on opposite sides</p>		<ul style="list-style-type: none">  1-5/8" Type S drywall screws 8" o.c. at edges and 12" o.c. in the field. (For fire, minimum 1-5/8" screws spaced 12" o.c.)











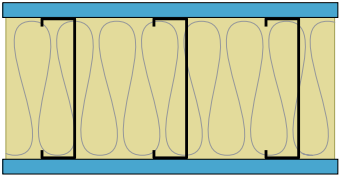

24" o.c.	16" o.c.	Description
<p>PGD-54-644-24</p> <p>STC 47 NOAL 19-0725 – 24" o.c.</p>  <p>Fire: 1 Hour - UL U425</p> <p>Thickness: 5-3/8" Approx weight: 5.7 lb/ft²</p>	<p>PGD-54-644-16</p> <p>STC 46 NOAL 18-0623 – 16" o.c.</p>  <p>Fire: 1 Hour - UL U425</p> <p>Thickness: 5-3/8" Approx weight: 5.9 lb/ft²</p>	<ul style="list-style-type: none">  1-1/4" Type S drywall screws spaced 8" o.c. at edges and 12" o.c. in the field. (For fire, minimum 1" screws spaced 12" o.c.)  One layer: type X (FLAME CURB®, MOLD CURB® Plus, ABUSE CURB®, PABCO® Impact Resistant, PABCO® Glass Interior, PABCO® Glass Sheathing or PABCO® Gypsum Sheathing) gypsum panel applied vertically.  3-5/8" 54 mil steel studs, 24" o.c. or 16" o.c.  3-1/2", R-13 glass fiber insulation friction fit into stud cavity.  Resilient channel applied at right-angle, 24" o.c.  1/2" Type S screws attaching resilient channel to stud at each intersection.  One layer: 5/8" type X (FLAME CURB®, MOLD CURB® Plus, ABUSE CURB®, PABCO® Impact Resistant, PABCO® Glass Interior, PABCO® Glass Sheathing or PABCO® Gypsum Sheathing) gypsum panel applied vertically.  1" Type S drywall screws spaced 12" o.c. in the field.
<p>Load Bearing Vertical joints staggered on opposite sides</p>		



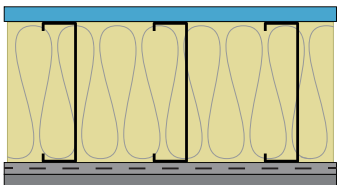



<p>PGD-54-664-24</p> <p>STC 46 NOAL 19-0723 – 24" o.c.</p>  <p>Fire: 1 Hour - UL U425</p> <p>Thickness: 4-7/8" Approx weight: 6.1 lb/ft²</p>	<p>PGD-54-664-16</p> <p>STC 41 NOAL 18-0512 – 16" o.c.</p>  <p>Fire: 1 Hour - UL U425</p> <p>Thickness: 4-7/8" Approx weight: 6.3 lb/ft²</p>	<ul style="list-style-type: none">  1-1/4" Type S drywall screws 8" o.c. at edges and 12" o.c. in the field (for fire, minimum 1" screws spaced 12" o.c.).  One layer: 5/8" QuietRock® ES or QuietRock® ES MR Type X gypsum panel applied vertically.  3-5/8" 54 mil steel studs, 24" o.c. or 16" o.c.  3-1/2", R-13 glass fiber insulation friction fit into stud cavity.  One layer: 5/8" type X (FLAME CURB®, MOLD CURB® Plus, ABUSE CURB®, PABCO® Impact Resistant, PABCO® Glass Interior, PABCO® Glass Sheathing or PABCO® Gypsum Sheathing) gypsum panel applied vertically.  1-1/4" Type S drywall screws 8" o.c. at edges and 12" o.c. in the field (for fire, minimum 1" screws spaced 12" o.c.).
<p>Load Bearing Vertical joints staggered on opposite sides</p>		



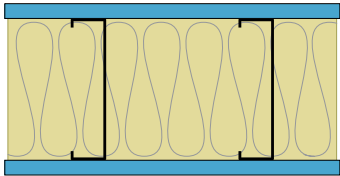
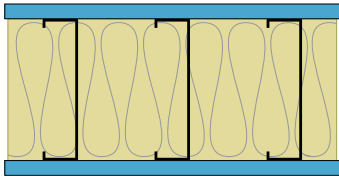



24" o.c.	16" o.c.	Description
<p>PGD-54-667-24</p> <p>STC 46 NOAL 19-0727 – 24" o.c.</p>  <p>Fire: 2 Hour - UL U411</p> <p>Thickness: 6-1/8" Approx weight: 9.7 lb/ft²</p>	<p>PGD-54-667-16</p> <p>STC 40 NOAL 21-0343 – 16" o.c.</p>  <p>Fire: 2 Hour - UL U411</p> <p>Thickness: 6-1/8" Approx weight: 10.0 lb/ft²</p>	<ul style="list-style-type: none">  1-5/8" Type S drywall screws spaced 8" o.c. at edges and 12" o.c. in the field.  Face layer: 5/8" type X (FLAME CURB®, PABCO® Glass Interior, PABCO® Glass Sheathing) gypsum panel applied vertically.  1-1/4" Type S drywall screws spaced 8" o.c. at edges and 12" o.c. in the field.  Base layer: 5/8" type X (FLAME CURB®, PABCO® Glass Interior, PABCO® Glass Sheathing) gypsum panel applied vertically.  3-5/8" 54 mil steel studs, 24" o.c. or 16" o.c.  3-1/2", R-13 glass fiber insulation friction fit into stud cavity.  Base layer: 5/8" type X (FLAME CURB®, PABCO® Glass Interior, PABCO® Glass Sheathing) gypsum panel applied vertically.  1-1/4" Type S drywall screws spaced 8" o.c. at edges and 12" o.c. in the field.  Face layer: 5/8" type X (FLAME CURB®, PABCO® Glass Interior, PABCO® Glass Sheathing) gypsum panel applied vertically.  1-5/8" Type S drywall screws spaced 8" o.c. at edges and 12" o.c. in the field.
<p>Load Bearing Vertical joints staggered on opposite sides</p>		
<p>PGD-54-797-24</p> <p>STC 40 NOAL 19-0726 – 24" o.c.</p>  <p>Fire: 1 Hour - UL U425</p> <p>Thickness: 4-7/8" Approx weight: 5.5lb/ft²</p>	<p>PGD-54-797-16</p> <p>STC 35 NOAL 21-0342 – 16" o.c.</p>  <p>Fire: 1 Hour - UL U425</p> <p>Thickness: 4-7/8" Approx weight: 5.9 lb/ft²</p>	<ul style="list-style-type: none">  1" Type S-12 drywall screws spaced 12" o.c.  One layer: type X (FLAME CURB®, MOLD CURB® Plus, ABUSE CURB®, PABCO® Impact Resistant, PABCO® Glass Interior, PABCO® Glass Sheathing or PABCO® Gypsum Sheathing) gypsum panel applied vertically.  3-5/8" 54 mil steel studs, 24" o.c. or 16" o.c.  3-1/2", R-13 glass fiber insulation friction fit into stud cavity.  One layer: type X (FLAME CURB®, MOLD CURB® Plus, ABUSE CURB®, PABCO® Impact Resistant, PABCO® Glass Interior, PABCO® Glass Sheathing or PABCO® Gypsum Sheathing) gypsum panel applied vertically.  1" Type S-12 drywall screws spaced 12" o.c.
<p>Load Bearing Vertical joints staggered on opposite sides</p>		



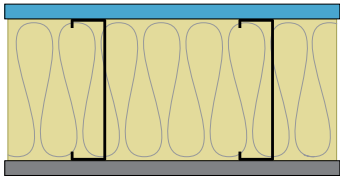
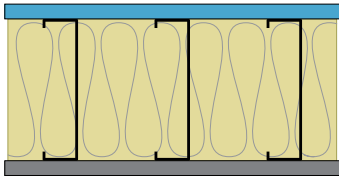





24" o.c.	16" o.c.	Description						
	<p align="center">PGD-546-353-16</p> <p align="center">STC 62</p> <p align="center">NOAL 18-1111 – 16" o.c.</p> <p align="center">Low Frequency Transmission Loss</p> <table border="1"> <tr> <td align="center">Hz</td> <td align="center">TL</td> </tr> <tr> <td align="center">80</td> <td align="center">26</td> </tr> <tr> <td align="center">100</td> <td align="center">35</td> </tr> </table>  <p align="center">Fire: 2 Hour - UL W466</p> <p align="center">Thickness: 8-3/4"</p> <p align="center">Approx weight: 14.3 lb/ft²</p>	Hz	TL	80	26	100	35	<ul style="list-style-type: none">  1-7/8" Type S drywall screws spaced 12" o.c. (for fire, minimum 2" screws)  One layer: 1-3/8" QuietRock® 545 gypsum panel applied vertically.  6" 54 mil steel studs, 16" o.c.  6-1/2", R-19 glass fiber insulation friction fit into stud cavity.  One layer: 1-3/8" QuietRock® 545 gypsum panel applied vertically.
Hz	TL							
80	26							
100	35							
<p align="center">Non-Load Bearing Vertical joints staggered on opposite sides</p>		<ul style="list-style-type: none">  1-7/8" Type S drywall screws spaced 12" o.c. (for fire, minimum 2" screws) 						

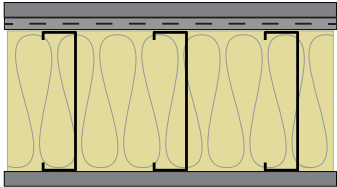





24" o.c.	16" o.c.	Description
	<p align="center">PGD-546-407-16</p> <p align="center">STC 60 NOAL 21-0358 – 16" o.c.</p>  <p align="center">Fire: 1 Hour - U425</p> <p align="center">Thickness: 8-3/8" Approx weight: 9.2 lb/ft²</p>	<ul style="list-style-type: none">  1" Type S drywall screws spaced 8" o.c. at edges and 12" o.c. in the field. (For fire, minimum 1" screws spaced 12" o.c.)  One layer: 5/8" QuietRock® ES or QuietRock® ES MR Type X gypsum panel applied vertically.  6" 54 mil steel studs, 16" o.c.  6-1/4", R-19 glass fiber insulation friction fit into stud cavity.  Resilient channel applied at right-angle, 24" o.c.  1/2" Type S screws attaching resilient channel to stud at each intersection.  Base layer: type X (FLAME CURB®, MOLD CURB® Plus, ABUSE CURB®, PABCO® Impact Resistant, PABCO® Glass Interior, PABCO® Glass Sheathing or PABCO® Gypsum Sheathing) gypsum panel applied vertically.  1" Type S drywall screws spaced 12" o.c.  Face layer: 5/8" type X (FLAME CURB®, MOLD CURB® Plus, ABUSE CURB®, PABCO® Impact Resistant, PABCO® Glass Interior, PABCO® Glass Sheathing or PABCO® Gypsum Sheathing) gypsum panel applied vertically.
<p align="center">Load Bearing Vertical joints staggered on opposite sides</p>		<ul style="list-style-type: none">  1-5/8" Type S drywall screws spaced 12" o.c.



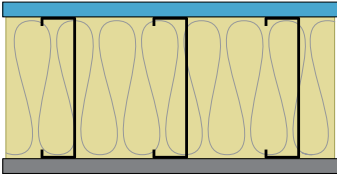



24" o.c.	16" o.c.	Description
	<p align="center">PGD-546-425-16</p> <p align="center">STC 54</p> <p align="center">NOAL 21-0362- 16" o.c.</p>  <p align="center">Fire: 1 Hour - UL V464 Configuration A</p> <p align="center">Thickness: 7-1/4" Approx weight: 7.7 lb/ft²</p>	<ul style="list-style-type: none">  1" Type S drywall screws 8" o.c. at edges and 12" o.c. in the field. (For fire, minimum 1-1/4" screws)  One layer: 5/8" QuietRock® 530 or QuietRock® 530 RF gypsum panel applied vertically.  6" 54 mil steel studs, 16" o.c.  6-1/4", R-19 glass fiber insulation friction fit into stud cavity.  One layer: 5/8" QuietRock® 530 or QuietRock® 530 RF gypsum panel applied vertically.
<p align="center">Non-Load Bearing Vertical joints staggered on opposite sides</p>		<ul style="list-style-type: none">  1" Type S drywall screws 8" o.c. at edges and 12" o.c. in the field. (For fire, minimum 1-1/4" screws)
	<p align="center">PGD-546-427-16</p> <p align="center">STC 54</p> <p align="center">NOAL 21-0357 - 16" o.c.</p>  <p align="center">Fire: 1 Hour - UL U425</p> <p align="center">Thickness: 7-3/4" Approx weight: 7.1 lb/ft²</p>	<ul style="list-style-type: none">  1" Type S drywall screws 8" o.c. at edges and 12" o.c. in the field. (For fire, minimum 1" screws spaced 12" o.c.)  One layer: 5/8" QuietRock® ES or QuietRock® ES MR Type X gypsum panel applied vertically.  6" 54 mil steel studs, 16" o.c.  6-1/4", R-19 glass fiber insulation friction fit into stud cavity.  Resilient channel applied at right-angle, 24" o.c.  1/2" Type S screws attaching resilient channel to stud at each intersection.  One layer: 5/8" type X (FLAME CURB®, MOLD CURB® Plus, ABUSE CURB®, PABCO® Impact Resistant, PABCO® Glass Interior, PABCO® Glass Sheathing or PABCO® Gypsum Sheathing) gypsum panel applied vertically.
<p align="center">Load Bearing Vertical joints staggered on opposite sides</p>		<ul style="list-style-type: none">  1" Type S drywall screws spaced 12" o.c.



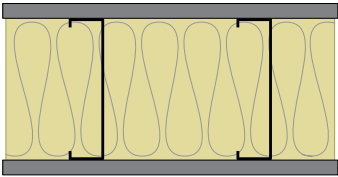





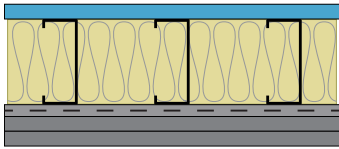

24" o.c.	16" o.c.	Description
<p>PGD-546-493-24</p> <p>STC 55 NOAL 18-1114 – 24" o.c.</p>  <p>Fire: 1 Hour - UL U425</p> <p>Thickness: 7-1/4" Approx weight: 7.1 lb/ft²</p>	<p>PGD-546-493-16</p> <p>STC 48 NOAL 21-0356 – 16" o.c.</p>  <p>Fire: 1 Hour - UL U425</p> <p>Thickness: 7-1/4" Approx weight: 7.6 lb/ft²</p>	<ul style="list-style-type: none">  1" Type S drywall screws 8" o.c. at edges and 12" o.c. in the field. (For fire, minimum 1" screws spaced 12" o.c.)  One layer: 5/8" QuietRock® ES or QuietRock® ES MR Type X gypsum panel applied vertically.  6" 54 mil steel studs, 24" o.c. or 16" o.c.  6", R-19 glass fiber insulation friction fit into stud cavity.  One layer: 5/8" QuietRock® ES or QuietRock® ES MR type X gypsum panel applied vertically.  1" Type S drywall screws 8" o.c. at edges and 12" o.c. in the field. (For fire, minimum 1" screws spaced 12" o.c.)
<p>Load Bearing Vertical joints staggered on opposite sides</p>		









<p>PGD-546-576-24</p> <p>STC 51 NOAL 18-1115 – 24" o.c.</p>  <p>Fire: 1 Hour - UL U425</p> <p>Thickness: 7-1/4" Approx weight: 6.5 lb/ft²</p>	<p>PGD-546-576-16</p> <p>STC 44 NOAL 21-0355 – 16" o.c.</p>  <p>Fire: 1 Hour - UL U425</p> <p>Thickness: 7-1/4" Approx weight: 7.0 lb/ft²</p>	<ul style="list-style-type: none">  1" Type S drywall screws 12" o.c.  One layer: 5/8" QuietRock® ES or QuietRock® ES MR Type X gypsum panel applied vertically.  6" 54 mil steel studs, 24" o.c. or 16" o.c.  6", R-19 glass fiber insulation friction fit into stud cavity.  One layer: 5/8" type X (FLAME CURB®, MOLD CURB® Plus, ABUSE CURB®, PABCO® Impact Resistant, PABCO® Glass Interior, PABCO® Glass Sheathing or PABCO® Gypsum Sheathing) gypsum panel applied vertically.  1" Type S drywall screws 12" o.c.
<p>Load Bearing Vertical joints staggered on opposite sides</p>		

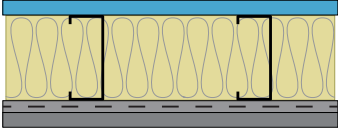
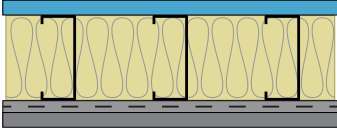







24" o.c.	16" o.c.	Description
	<p align="center">PGD-546-587-16</p> <p align="center">STC 48 NOAL 21-0360 – 16" o.c.</p>  <p>Fire: 1 Hour - UL U425</p> <p>Thickness: 7-3/4" Approx weight: 6.5 lb/ft²</p>	<ul style="list-style-type: none">  1" Type S drywall screws spaced 12" o.c.  One layer: 5/8" type X (FLAME CURB®, MOLD CURB® Plus, ABUSE CURB®, PABCO® Impact Resistant, PABCO® Glass Interior, PABCO® Glass Sheathing or PABCO® Gypsum Sheathing) gypsum panel applied vertically.  Resilient channel applied at right-angle, 24" o.c.  1/2" Type S screws attaching resilient channel to stud at each intersection.  6" 54 mil steel studs, 16" o.c.  6-1/4", R-19 glass fiber insulation friction fit into stud cavity.  One layer: 5/8" type X (FLAME CURB®, MOLD CURB® Plus, ABUSE CURB®, PABCO® Impact Resistant, PABCO® Glass Interior, PABCO® Glass Sheathing or PABCO® Gypsum Sheathing) gypsum panel applied vertically.
<p align="center">Load Bearing Vertical joints staggered on opposite sides</p>		<ul style="list-style-type: none">  1" Type S drywall screws 8" o.c. at edges and 12" o.c. in the field. (For fire, minimum 1" screws spaced 12" o.c.)

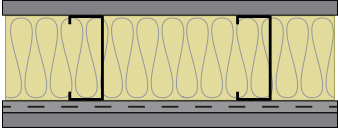
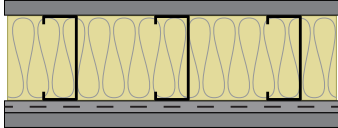







	<p align="center">PGD-546-595-16</p> <p align="center">STC 47 NOAL 21-0361 – 16" o.c.</p>  <p>Fire: 1 Hour - UL V464 Configuration A</p> <p>Thickness: 7-1/4" Approx weight: 7.1 lb/ft²</p>	<ul style="list-style-type: none">  1" Type S drywall screws 8" o.c. at edges and 12" o.c. in the field. (For fire, minimum 1-1/4" screws)  One layer: 5/8" QuietRock® 530 or QuietRock® 530 RF gypsum panel applied vertically.  6" 54 mil steel studs, 16" o.c.  6-1/4", R-19 glass fiber insulation friction fit into stud cavity.  One layer: 5/8" type X (FLAME CURB®, MOLD CURB® Plus, ABUSE CURB®, PABCO® Impact Resistant, PABCO® Glass Interior, PABCO® Glass Sheathing or PABCO® Gypsum Sheathing) gypsum panel applied vertically.
<p align="center">Non-Load Bearing Vertical joints staggered on opposite sides</p>		<ul style="list-style-type: none">  1" Type S drywall screws 8" o.c. at edges and 12" o.c. in the field. (For fire, minimum 1-1/4" screws)

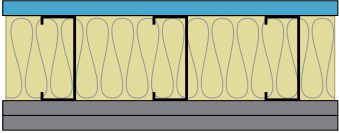





24" o.c.	16" o.c.	Description
<p>PGD-546-738-24</p> <p>STC 43 NOAL 18-1120 – 24" o.c.</p>  <p>Fire: 1 Hour - UL U425</p> <p>Thickness: 7-1/4" Approx weight: 5.6 lb/ft²</p>		<ul style="list-style-type: none">  1" Type S drywall screws 12" o.c.  One layer: 5/8" Type X (FLAME CURB®, MOLD CURB® Plus, ABUSE CURB®, PABCO® Impact Resistant, PABCO® Glass Interior, PABCO® Glass Sheathing or PABCO® Gypsum Sheathing) gypsum panel applied vertically.  6" 43 mil steel studs, 24" o.c.  6-1/2", R-19 glass fiber insulation friction fit into stud cavity  One layer: 5/8" Type X (FLAME CURB®, MOLD CURB® Plus, ABUSE CURB®, PABCO® Impact Resistant, PABCO® Glass Interior, PABCO® Glass Sheathing or PABCO® Gypsum Sheathing) gypsum panel applied vertically.
<p>Load Bearing Vertical joints staggered on opposite sides</p>		<ul style="list-style-type: none">  1" Type S drywall screws 12" o.c.









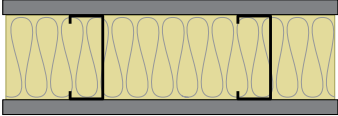
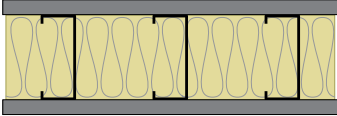

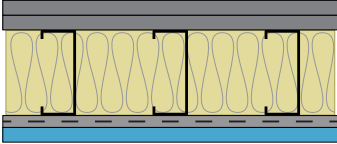
24" o.c.	16" o.c.	Description
	<p style="text-align: center;">PGD-68-396-16</p> <p style="text-align: center;">STC 56 NOAL 18-0612 – 16" o.c.</p>  <p style="text-align: center;">Fire: 1 Hour - UL U425</p> <p style="text-align: center;">Thickness: 6" Approx weight: 9.0 lb/ft²</p>	<ul style="list-style-type: none">  1-1/4" Type S screws spaced 8" o.c. at edges and 12" o.c. in the field. (for fire, minimum 1" screws spaced 12" o.c.)  One layer: 5/8" QuietRock® ES or QuietRock® ES MR type X gypsum panel applied vertically.  3-5/8" 68 mil steel studs, 16" o.c.  3-1/2", R-13 glass fiber insulation friction fit into stud cavity.  Resilient channel applied at right-angle, 24" o.c.  1/2" Type S screws attaching resilient channel to stud at each intersection.  Base layer: 5/8" type X (FLAME CURB®, MOLD CURB® Plus, ABUSE CURB®, PABCO® Impact Resistant, PABCO® Glass Interior, PABCO® Glass Sheathing or PABCO® Gypsum Sheathing) gypsum panel applied vertically.  1" Type S drywall screws spaced 12" o.c.  Face layer: 5/8" type X (FLAME CURB®, MOLD CURB® Plus, ABUSE CURB®, PABCO® Impact Resistant, PABCO® Glass Interior, PABCO® Glass Sheathing or PABCO® Gypsum Sheathing) gypsum panel applied vertically.
<p>Load Bearing Vertical joints staggered on opposite sides</p>		<ul style="list-style-type: none">  1-5/8" Type S drywall screws at 12" o.c.









24" o.c.	16" o.c.	Description
<p style="text-align: center;">PGD-68-534-24</p> <p style="text-align: center;">STC 53 NOAL 19-0718 – 24" o.c.</p>  <p>Fire: 1 Hour - UL U425</p> <p>Thickness: 5-3/8" Approx weight: 6.5 lb/ft²</p>	<p style="text-align: center;">PGD-68-534-16</p> <p style="text-align: center;">STC 50 NOAL 18-0611 – 16" o.c.</p>  <p>Fire: 1 Hour - UL U425</p> <p>Thickness: 5-3/8" Approx weight: 6.9 lb/ft²</p>	<ul style="list-style-type: none">  1-1/4" Type S screws spaced 8" o.c. at edges and 12" o.c. in the field. (for fire, minimum 1" screws spaced 12" o.c.)  One layer: 5/8" QuietRock® ES or QuietRock® ES MR type X gypsum panel applied vertically.  3-5/8" 68 mil steel studs, 24" o.c. or 16" o.c.  3-1/2", R-13 glass fiber insulation friction fit into stud cavity.  Resilient channel applied at right-angle, 24" o.c.  1/2" Type S screws attaching resilient channel to stud at each intersection.  One layer: 5/8" type X (FLAME CURB®, MOLD CURB® Plus, ABUSE CURB®, PABCO® Impact Resistant, PABCO® Glass Interior, PABCO® Glass Sheathing or PABCO® Gypsum Sheathing) gypsum panel applied vertically.
<p>Load Bearing Vertical joints staggered on opposite sides</p>		<ul style="list-style-type: none">  1" Type S drywall screws spaced 12" o.c.

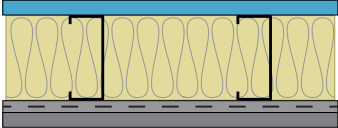
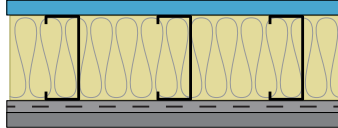







24" o.c.	16" o.c.	Description
<p style="text-align: center;">PGD-68-607-24</p> <p style="text-align: center;">STC 49 NOAL 19-0719 – 24" o.c.</p>  <p>Fire: 1 Hour - UL U425</p> <p>Thickness: 5-3/8" Approx weight: 6.5 lb/ft²</p>	<p style="text-align: center;">PGD-68-607-16</p> <p style="text-align: center;">STC 46 NOAL 18-0616 – 16" o.c.</p>  <p>Fire: 1 Hour - UL U425</p> <p>Thickness: 5-3/8" Approx weight: 6.3 lb/ft²</p>	<ul style="list-style-type: none">  1-1/4" Type S drywall screws spaced 8" o.c. at edges and 12" o.c. in the field. (for fire, minimum 1" screws spaced 12" o.c.)  One layer: 5/8" type X (FLAME CURB®, MOLD CURB® Plus, ABUSE CURB®, PABCO® Impact Resistant, PABCO® Glass Interior, PABCO® Glass Sheathing or PABCO® Gypsum Sheathing) gypsum panel applied vertically.  3-5/8" 68 mil steel studs, 24" o.c. or 16" o.c.  3-1/2", R-13 glass fiber insulation friction fit into stud cavity.  Resilient channel applied at right-angle, 24" o.c.  1/2" Type S screws attaching resilient channel to stud at each intersection.  One layer: 5/8" type X (FLAME CURB®, MOLD CURB® Plus, ABUSE CURB®, PABCO® Impact Resistant, PABCO® Glass Interior, PABCO® Glass Sheathing or PABCO® Gypsum Sheathing) gypsum panel applied vertically.
<p>Load Bearing Vertical joints staggered on opposite sides</p>		<ul style="list-style-type: none">  1" Type S drywall screws spaced 12" o.c.

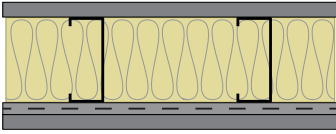
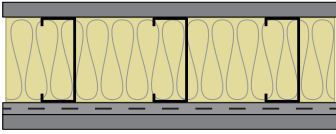







24" o.c.	16" o.c.	Description
	<p align="center">PGD-68-612-16</p> <p align="center">STC 45 NOAL 18-0608 – 16" o.c.</p>  <p align="center">Fire: 1 Hour - UL U425</p> <p align="center">Thickness: 5-1/2" Approx weight: 8.8 lb/ft²</p>	<ul style="list-style-type: none">  1-1/4" Type S drywall screws spaced 8" o.c. at edges and 12" o.c. in the field. (for fire, minimum 1" screws spaced 12" o.c.)  One layer: 5/8" QuietRock® ES or QuietRock® ES MR type X gypsum panel applied vertically.  3-5/8" 68 mil steel studs, 16" o.c.  3-1/2", R-13 glass fiber insulation friction fit into stud cavity.  Base layer: 5/8" type X (FLAME CURB®, MOLD CURB® Plus, ABUSE CURB®, PABCO® Impact Resistant, PABCO® Glass Interior, PABCO® Glass Sheathing or PABCO® Gypsum Sheathing) gypsum panel applied vertically.  1-1/4" Type S drywall screws spaced 8" o.c. at edges and 12" o.c. in the field. (for fire, minimum 1" screws spaced 12" o.c.)  Face layer: 5/8" type X (FLAME CURB®, MOLD CURB® Plus, ABUSE CURB®, PABCO® Impact Resistant, PABCO® Glass Interior, PABCO® Glass Sheathing or PABCO® Gypsum Sheathing) gypsum panel applied vertically.
<p align="center">Load Bearing Vertical joints staggered on opposite sides</p>		<ul style="list-style-type: none">  1-5/8" Type S drywall screws spaced 8" o.c. at edges and 12" o.c. in the field. (for fire, minimum 1-5/8" screws spaced 12" o.c.)

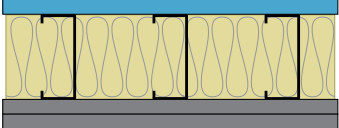





24" o.c.	16" o.c.	Description
<p>PGD-68-798-24</p>	<p>PGD-68-798-16</p>	<p> 1-1/4" Type S drywall screws spaced 8" o.c. at edges and 12" o.c. in the field. (for fire, minimum 1" screws spaced 12" o.c.)</p> <p> One layer: 5/8" type X (FLAME CURB®, MOLD CURB® Plus, ABUSE CURB®, PABCO® Impact Resistant, PABCO® Glass Interior, PABCO® Glass Sheathing or PABCO® Gypsum Sheathing) gypsum panel applied vertically.</p> <p> 3-5/8" 68 mil steel studs, 24" o.c. or 16" o.c.</p> <p> 3-1/2", R-13 glass fiber insulation friction fit into stud cavity.</p> <p> One layer: 5/8" type X (FLAME CURB®, MOLD CURB® Plus, ABUSE CURB®, PABCO® Impact Resistant, PABCO® Glass Interior, PABCO® Glass Sheathing or PABCO® Gypsum Sheathing) gypsum panel applied vertically.</p> <p> 1-1/4" Type S drywall screws spaced 8" o.c. at edges and 12" o.c. in the field. (for fire, minimum 1" screws spaced 12" o.c.)</p>
<p>STC 40 NOAL 19-0721 – 24" o.c.</p>  <p>Fire: 1 Hour - UL U425</p> <p>Thickness: 4-7/8" Approx weight: 5.8 lb/ft²</p>	<p>STC 38 NOAL 18-0623 – 16" o.c.</p>  <p>Fire: 1 Hour - UL U425</p> <p>Thickness: 4-7/8" Approx weight: 6.2 lb/ft²</p>	
<p>Load Bearing Vertical joints staggered on opposite sides</p>		

24" o.c.	16" o.c.	Description
	<p align="center">PGD-97-466-16</p> <p align="center">STC 56 NOAL 18-0732 – 16" o.c.</p>  <p>Fire: 1 Hour - UL U425</p> <p>Thickness: 6" Approx weight: 9.9 lb/ft²</p>	<ul style="list-style-type: none">  1-5/8" Type S drywall screws spaced 8" o.c. at edges and 12" o.c. in the field. (for fire, minimum 1-5/8" screws spaced 12" o.c.)  Face layer: 5/8" type X (FLAME CURB®, MOLD CURB® Plus, ABUSE CURB®, PABCO® Impact Resistant, PABCO® Glass Interior, PABCO® Glass Sheathing or PABCO® Gypsum Sheathing) gypsum panel applied vertically.  1-1/4" Type S drywall screws spaced 8" o.c. at edges and 12" o.c. in the field. (for fire, minimum 1" screws spaced 12" o.c.)  Base layer: 5/8" type X (FLAME CURB®, MOLD CURB® Plus, ABUSE CURB®, PABCO® Impact Resistant, PABCO® Glass Interior, PABCO® Glass Sheathing or PABCO® Gypsum Sheathing) gypsum panel applied vertically.  3-5/8" 97 mil steel studs, 16" o.c.  3-1/2", R-13 glass fiber insulation friction fit into stud cavity.  Resilient channel applied at right-angle, 24" o.c.  1/2" Type S screws attaching resilient channel to stud at each intersection.  One layer: 5/8" QuietRock® ES or QuietRock® ES MR type X gypsum panel applied vertically.
<p align="center">Load Bearing Vertical joints staggered on opposite sides</p>		<ul style="list-style-type: none">  1" Type S drywall screws spaced 12" o.c.

24" o.c.	16" o.c.	Description
<p data-bbox="196 348 375 375">PGD-97-516-24</p> <p data-bbox="228 491 342 527">STC 54</p> <p data-bbox="172 535 399 562">NOAL 19-0736 – 24" o.c.</p>  <p data-bbox="131 833 347 858">Fire: 1 Hour - UL U425</p> <p data-bbox="131 898 298 924">Thickness: 5-3/8"</p> <p data-bbox="131 932 370 957">Approx weight: 7.1 lb/ft²</p>	<p data-bbox="578 348 756 375">PGD-97-516-16</p> <p data-bbox="610 491 724 527">STC 50</p> <p data-bbox="553 535 781 562">NOAL 18-0729 – 16" o.c.</p>  <p data-bbox="509 833 725 858">Fire: 1 Hour - UL U425</p> <p data-bbox="509 898 677 924">Thickness: 5-3/8"</p> <p data-bbox="509 932 748 957">Approx weight: 7.7 lb/ft²</p>	<ul style="list-style-type: none"> <li data-bbox="873 380 1503 426"> 1-1/4" Type S drywall screws spaced 8" o.c. at edges and 12" o.c. in the field. (for fire, minimum 1" screws spaced 12" o.c.) <li data-bbox="873 468 1487 514"> One layer: 5/8" QuietRock® ES or QuietRock® ES MR type X gypsum panel applied vertically. <li data-bbox="873 556 1338 602"> 3-5/8" 97 mil steel studs, 24" o.c. or 16" o.c. <li data-bbox="873 644 1500 690"> 3-1/2", R-13 glass fiber insulation friction fit into stud cavity. <li data-bbox="873 732 1390 779"> Resilient channel applied at right-angle, 24" o.c. <li data-bbox="873 821 1468 867"> 1/2" Type S screws attaching resilient channel to stud at each intersection. <li data-bbox="873 909 1474 955"> One layer: 5/8" type X (FLAME CURB®, MOLD CURB® Plus, ABUSE CURB®, PABCO® Impact Resistant, PABCO® Glass Interior, PABCO® Glass Sheathing or PABCO® Gypsum Sheathing) gypsum panel applied vertically.
<p data-bbox="423 1089 548 1115">Load Bearing</p> <p data-bbox="289 1123 688 1148">Vertical joints staggered on opposite sides</p>		<ul style="list-style-type: none"> <li data-bbox="873 1094 1312 1140"> 1" Type S drywall screws spaced 12" o.c.

24" o.c.	16" o.c.	Description
<p style="text-align: center;">PGD-97-597-24</p> <p style="text-align: center;">STC 50 NOAL 19-0737 – 24" o.c.</p>  <p>Fire: 1 Hour - UL U425</p> <p>Thickness: 5-3/8" Approx weight: 6.5 lb/ft²</p>	<p style="text-align: center;">PGD-97-597-16</p> <p style="text-align: center;">STC 47 NOAL 18-0724 – 16" o.c.</p>  <p>Fire: 1 Hour - UL U425</p> <p>Thickness: 5-3/8" Approx weight: 7.2 lb/ft²</p>	<ul style="list-style-type: none">  1-1/4" Type S drywall screws spaced 8" o.c. at edges and 12" o.c. in the field. (for fire, minimum 1" screws spaced 12" o.c.)  One layer: 5/8" type X (FLAME CURB®, MOLD CURB® Plus, ABUSE CURB®, PABCO® Impact Resistant, PABCO® Glass Interior, PABCO® Glass Sheathing or PABCO® Gypsum Sheathing) gypsum panel applied vertically.  3-5/8" 97 mil steel studs, 24" o.c. or 16" o.c.  3-1/2", R-13 glass fiber insulation friction fit into stud cavity.  Resilient channel applied at right-angle, 24" o.c.  1/2" Type S screws attaching resilient channel to stud at each intersection.  One layer: 5/8" type X (FLAME CURB®, MOLD CURB® Plus, ABUSE CURB®, PABCO® Impact Resistant, PABCO® Glass Interior, PABCO® Glass Sheathing or PABCO® Gypsum Sheathing) gypsum panel applied vertically.
<p>Load Bearing Vertical joints staggered on opposite sides</p>		<ul style="list-style-type: none">  1" Type S drywall screws spaced 12" o.c.

24" o.c.	16" o.c.	Description
	<p align="center">PGD-97-602-16</p> <p align="center">STC 43 NOAL 18-0721 – 16" o.c.</p>  <p align="center">Fire: 1 Hour - UL U425</p> <p>Thickness: 5-1/2 Approx weight: 9.7 lb/ft²</p>	<ul style="list-style-type: none">  1-1/4" Type S drywall screws spaced 8" o.c. at edges and 12" o.c. in the field. (for fire, minimum 1" screws spaced 12" o.c.)  One layer: 5/8" QuietRock® ES or QuietRock® ES MR type X gypsum panel applied vertically.  3-5/8" 97 mil steel studs, 16" o.c.  3-1/2", R-13 glass fiber insulation friction fit into stud cavity.  Base layer: 5/8" type X (FLAME CURB®, MOLD CURB® Plus, ABUSE CURB®, PABCO® Impact Resistant, PABCO® Glass Interior, PABCO® Glass Sheathing or PABCO® Gypsum Sheathing) gypsum panel applied vertically.  1-1/4" Type S drywall screws spaced 8" o.c. at edges and 12" o.c. in the field. (for fire, minimum 1" screws spaced 12" o.c.)  Face layer: 5/8" type X (FLAME CURB®, MOLD CURB® Plus, ABUSE CURB®, PABCO® Impact Resistant, PABCO® Glass Interior, PABCO® Glass Sheathing or PABCO® Gypsum Sheathing) gypsum panel applied vertically.
<p>Load Bearing Vertical joints staggered on opposite sides</p>		<ul style="list-style-type: none">  1-5/8" Type S drywall screws spaced 8" o.c. at edges and 12" o.c. in the field. (for fire, minimum 1-5/8" screws spaced 12" o.c.)

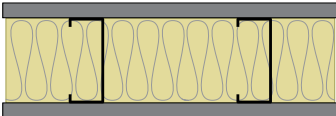
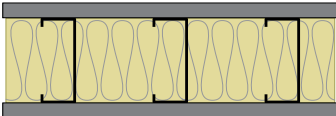
24" o.c.	16" o.c.	Description
<p>PGD-97-736-24</p>	<p>PGD-97-736-16</p>	<ul style="list-style-type: none">  1-1/4" Type S drywall screws spaced 8" o.c. at edges and 12" o.c. in the field. (For fire, minimum 1" screws spaced 12" o.c.)  One layer: 5/8" type X (FLAME CURB®, MOLD CURB® Plus, ABUSE CURB®, PABCO® Impact Resistant, PABCO® Glass Interior, PABCO® Glass Sheathing or PABCO® Gypsum Sheathing) gypsum panel applied vertically.  3-5/8" 97 mil steel studs, 24" o.c. or 16" o.c.  3-1/2", R-13 glass fiber insulation friction fit into stud cavity.  One layer: 5/8" type X (FLAME CURB®, MOLD CURB® Plus, ABUSE CURB®, PABCO® Impact Resistant, PABCO® Glass Interior, PABCO® Glass Sheathing or PABCO® Gypsum Sheathing) gypsum panel applied vertically.  1-1/4" Type S drywall screws spaced 8" o.c. at edges and 12" o.c. in the field. (For fire, minimum 1" screws spaced 12" o.c.)
<p>STC 43 NOAL 19-0738 – 24" o.c.</p>  <p>Fire: 1 Hour - UL U425</p> <p>Thickness: 4-7/8" Approx weight: 6.4 lb/ft²</p>	<p>STC 38 NOAL 18-0603 – 16" o.c.</p>  <p>Fire: 1 Hour - UL U425</p> <p>Thickness: 4-7/8" Approx weight: 6.9 lb/ft²</p>	
<p style="text-align: center;">Load Bearing Vertical joints staggered on opposite sides</p>		

Walls & Interior Partitions

Staggered Steel Frame

ASSEMBLY COMPONENTS AND PICTOGRAMS

The assemblies in this guide have been divided into sections by framing material type and ordered by design file number. The assembly details are listed in order starting from the outermost layer (attachment); working from top to bottom and ending with the stud or insulation. Pictograms have been added to each assembly detail to provide visual separation of the individual assembly components.

Attachment: identifies screw/nail type, placement, and spacing for attachment of the face layer



QuietRock Layer: identifies the QuietRock product use as a face layer



Framing: Identifies stud framing material, size, thickness, spacing and/or unique framing methods



Insulation: Identifies insulation type, size used to fill assembly cavity (if applicable)



Base Layer: Identifies the PABCO Gypsum product that may be used



Attachment: identifies screw/nail type, placement, and spacing for attachment of the face layer









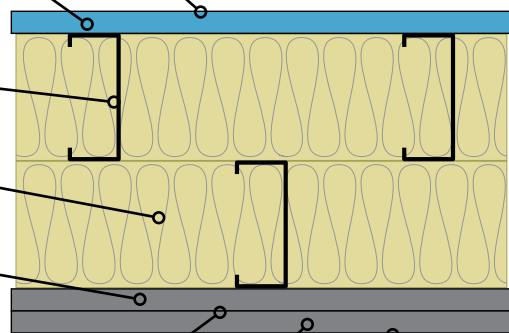

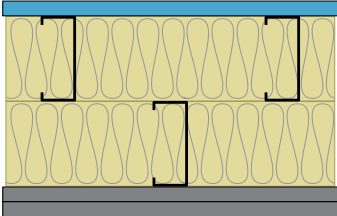





Face Layer: Identifies the PABCO Gypsum product that may be used



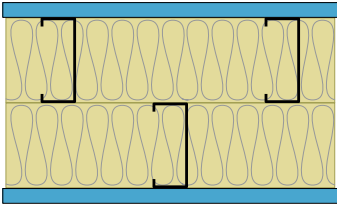





Attachment: identifies screw/nail type, placement, and spacing for attachment of the face layer

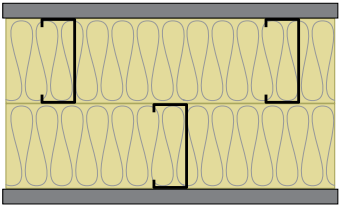

24" o.c.	16" o.c.	Description
	<p align="center">PGD-15S-286-16</p> <p align="center">STC 65 NOAL 17-0914 – 16" o.c.</p>  <p align="center">Fire: 1 Hour - UL V464 Configuration B</p> <p align="center">Thickness: 9-1/8" Approx weight: 8.1 lb/ft²</p>	<ul style="list-style-type: none">  1" Type S drywall screws spaced 8" o.c. at edges and 12" o.c. in the field.  One layer: 5/8" QuietRock® ES or QuietRock® ES MR type X gypsum panel applied vertically.  Staggered-double row 3-5/8" 15 mil steel studs, 16" o.c.  6-1/4", R-19 glass fiber insulation friction fit into stud cavity.  Base layer: 5/8" type X (FLAME CURB®, MOLD CURB® Plus, ABUSE CURB®, PABCO® Impact Resistant, PABCO® Glass Interior, PABCO® Glass Sheathing or PABCO® Gypsum Sheathing) gypsum panel applied vertically.  1" Type S drywall screws spaced 8" o.c. at edges and 12" o.c. in the field.  Face layer: 5/8" type X (FLAME CURB®, MOLD CURB® Plus, ABUSE CURB®, PABCO® Impact Resistant, PABCO® Glass Interior, PABCO® Glass Sheathing or PABCO® Gypsum Sheathing) gypsum panel applied vertically.
<p align="center">Non-Load Bearing Vertical joints staggered on opposite sides</p>		<ul style="list-style-type: none">  1-1/4" Type S drywall screws spaced 8" o.c. at edges and 12" o.c. in the field. (For fire, minimum 1" screws spaced 12" o.c.)

24" o.c.	16" o.c.	Description
	<p style="text-align: center;">PGD-15S-337-16</p> <p style="text-align: center;">STC 63 NOAL 17-0912 – 16" o.c.</p>  <p style="text-align: center;">Fire: 1 Hour - UL V464 Configuration B GA WP-0952</p> <p style="text-align: center;">Thickness: 8-1/2" Approx weight: 6.7 lb/ft²</p>	<ul style="list-style-type: none">  1" Type S drywall screws spaced 8" o.c. at edges and 12" o.c. in the field. (For fire, minimum 1-1/4" screws spaced 12" o.c.)  One layer: 5/8" QuietRock® ES or QuietRock® ES MR type X gypsum panel applied vertically.  Staggered-double row 3-5/8" 15 mil steel studs, 16" o.c.  6-1/4", R-19 glass fiber insulation friction fit into stud cavity.  One layer: 5/8" QuietRock® ES or QuietRock® ES MR type X gypsum panel applied vertically.
<p>Non-Load Bearing Vertical joints staggered on opposite sides</p>		<ul style="list-style-type: none">  1-1/4" Type S drywall screws spaced 8" o.c. at edges and 12" o.c. in the field. (For fire, minimum 1-1/4" screws spaced 12" o.c.)

24" o.c.	16" o.c.	Description
	<p>PGD-15S-468-16</p> <p>STC 56</p> <p>NOAL 17-0917 – 16" o.c.</p>  <p>Fire: 1 Hour - UL V464 Configuration B</p> <p>Thickness: 8-1/2"</p> <p>Approx weight: 5.2 lb/ft²</p>	<ul style="list-style-type: none">  1" Type S drywall screws spaced 8" o.c. at edges and 12" o.c. in the field.  One layer: 5/8" type X (FLAME CURB®, MOLD CURB® Plus, ABUSE CURB®, PABCO® Impact Resistant, PABCO® Glass Interior, PABCO® Glass Sheathing or PABCO® Gypsum Sheathing) gypsum panel applied vertically.  Staggered-double row (no air space) 3-5/8" 15 mil steel studs, 16" o.c.  6-1/4", R-19 glass fiber insulation friction fit into stud cavity.  One layer: 5/8" type X (FLAME CURB®, MOLD CURB® Plus, ABUSE CURB®, PABCO® Impact Resistant, PABCO® Glass Interior, PABCO® Glass Sheathing or PABCO® Gypsum Sheathing) gypsum panel applied vertically.
<p>Non-Load Bearing</p> <p>Vertical joints staggered on opposite sides</p>		<ul style="list-style-type: none">  1" Type S drywall screws spaced 8" o.c. at edges and 12" o.c. in the field.









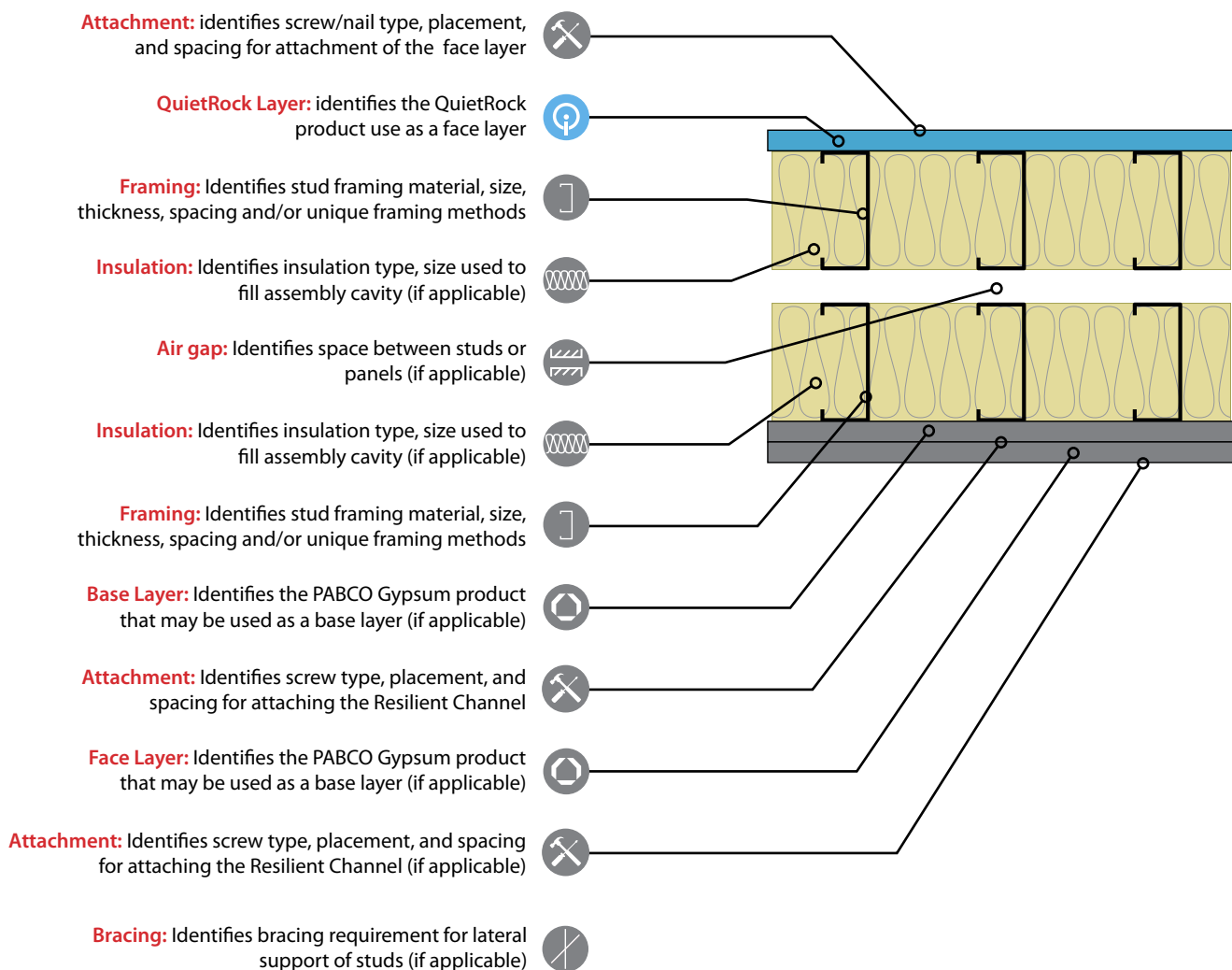

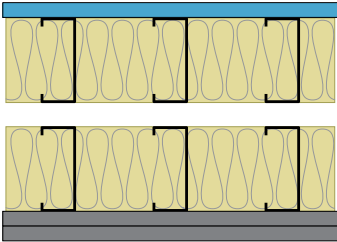

Walls & Interior Partitions









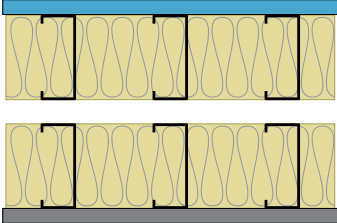

Double Steel Frame









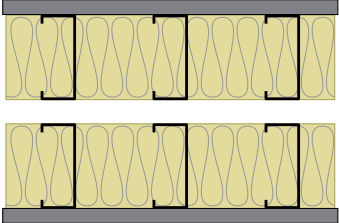

ASSEMBLY COMPONENTS AND PICTOGRAMS

The assemblies in this guide have been divided into sections by framing material type and ordered by design file number. The assembly details are listed in order starting from the outermost layer (attachment); working from top to bottom and ending with the stud or insulation. Pictograms have been added to each assembly detail to provide visual separation of the individual assembly components.











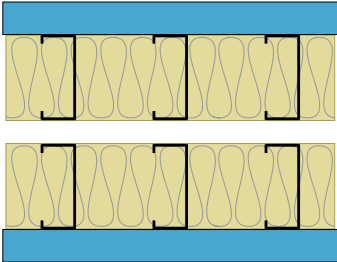









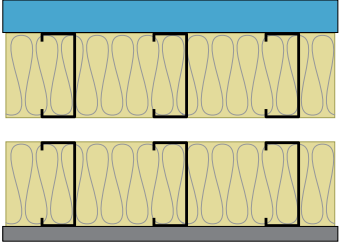

24" o.c.	16" o.c.	Description
	<p align="center">PGD-15D-265-16</p> <p align="center">STC 66 NOAL 17-0926 – 16" o.c.</p>  <p>Fire: 1 Hour - UL V464 Configuration C</p> <p>Thickness: 10-1/8" Approx weight: 8.0 lb/ft²</p>	<ul style="list-style-type: none">  1" Type S drywall screws spaced 8" o.c. at edges and 12" o.c. in the field.  One layer: 5/8" QuietRock® ES or QuietRock® ES MR type X gypsum panel applied vertically.  3-1/2", R-11 glass fiber insulation friction fit into stud cavity.  3-5/8" 15 mil steel studs, 16" o.c.  1" air gap.  3-5/8" 15 mil steel studs, 16" o.c.  3-1/2", R-11 glass fiber insulation friction fit into stud cavity.  Base layer: 5/8" type X (FLAME CURB®, MOLD CURB® Plus, ABUSE CURB®, PABCO® Impact Resistant, PABCO® Glass Interior, PABCO® Glass Sheathing or PABCO® Gypsum Sheathing) gypsum panel applied vertically.  1" Type S drywall screws spaced 8" o.c. at edges and 12" o.c. in the field.  Face layer: 5/8" type X (FLAME CURB®, MOLD CURB® Plus, ABUSE CURB®, PABCO® Impact Resistant, PABCO® Glass Interior, PABCO® Glass Sheathing or PABCO® Gypsum Sheathing) gypsum panel applied vertically.
<p align="center">Non-Load Bearing Vertical joints staggered on opposite sides</p>		<ul style="list-style-type: none">  2" Type S drywall screws spaced 8" o.c. at edges and 12" o.c. in the field.









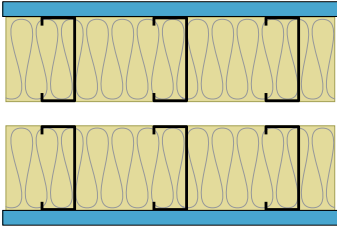

24" o.c.	16" o.c.	Description
	<p align="center">PGD-15D-375-16</p> <p align="center">STC 61 NOAL 17-0925 – 16" o.c.</p>  <p align="center">Fire: 1 Hour - UL V464 Configuration C</p> <p>Thickness: 9-1/2" Approx weight: 5.9 lb/ft²</p>	<ul style="list-style-type: none">  1" Type S drywall screws spaced 8" o.c. at edges and 12" o.c. in the field.  One layer: 5/8" QuietRock® ES or QuietRock® ES MR type X gypsum panel applied vertically.  3-1/2", R-11 glass fiber insulation friction fit into stud cavity.  3-5/8" 15 mil steel studs, 16" o.c.  1" air gap.  3-5/8" 15 mil steel studs, 16" o.c.  3-1/2", R-11 glass fiber insulation friction fit into stud cavity.  One layer: 5/8" type X (FLAME CURB®, MOLD CURB® Plus, ABUSE CURB®, PABCO® Impact Resistant, PABCO® Glass Interior, PABCO® Glass Sheathing or PABCO® Gypsum Sheathing) gypsum panel applied vertically.
<p align="center">Non-Load Bearing Vertical joints staggered on opposite sides</p>		<ul style="list-style-type: none">  1" Type S drywall screws spaced 8" o.c. at edges and 12" o.c. in the field.









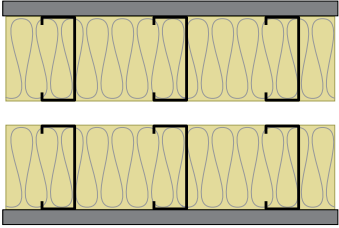

24" o.c.	16" o.c.	Description
	<p align="center">PGD-15D-423-16</p> <p align="center">STC 58</p> <p align="center">NOAL 17-0929 – 16" o.c.</p>  <p align="center">Fire: 1 Hour - UL V464 Configuration C</p> <p align="center">Thickness: 9-1/2" Approx weight: 5.3 lb/ft²</p>	<ul style="list-style-type: none">  1" Type S drywall screws spaced 8" o.c. at edges and 12" o.c. in the field.  One layer: 5/8" type X (FLAME CURB®, MOLD CURB® Plus, ABUSE CURB®, PABCO® Impact Resistant, PABCO® Glass Interior, PABCO® Glass Sheathing or PABCO® Gypsum Sheathing) gypsum panel applied vertically.  3-1/2", R-11 glass fiber insulation friction fit into stud cavity.  3-5/8" 15 mil steel studs, 16" o.c.  1" air gap.  3-5/8" 15 mil steel studs, 16" o.c.  3-1/2", R-11 glass fiber insulation friction fit into stud cavity.  One layer: 5/8" type X (FLAME CURB®, MOLD CURB® Plus, ABUSE CURB®, PABCO® Impact Resistant, PABCO® Glass Interior, PABCO® Glass Sheathing or PABCO® Gypsum Sheathing) gypsum panel applied vertically.
<p align="center">Non-Load Bearing Vertical joints staggered on opposite sides</p>		<ul style="list-style-type: none">  1" Type S drywall screws spaced 8" o.c. at edges and 12" o.c. in the field.











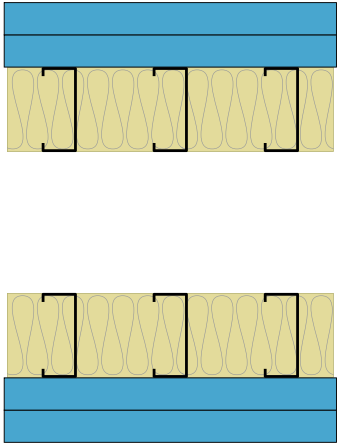



24" o.c.	16" o.c.	Description						
	<p align="center">PGD-33D-145-16</p> <p align="center">STC 80 NOAL 20-0753 – 16" o.c.</p> <p align="center">Low Frequency Transmission Loss</p> <table border="1"> <tr> <td>Hz</td> <td>TL</td> </tr> <tr> <td>80</td> <td>46</td> </tr> <tr> <td>100</td> <td>52</td> </tr> </table> <p align="center">Fire: Non-Rated</p> <p>Thickness: 13-3/4" Approx weight: 26.4 lb/ft²</p>	Hz	TL	80	46	100	52	<ul style="list-style-type: none"> 3-1/2" Type S drywall screws spaced 8" o.c. at edges and 12" o.c. in the field. Face layer: 1-3/8" QuietRock® 545 gypsum panel applied vertically. 2" Type S drywall screws spaced 8" o.c. at edges and 12" o.c. in the field. Base layer: 1-3/8" QuietRock® 545 gypsum panel applied vertically. 3-1/2", R-13 glass fiber insulation friction fit into stud cavity. 3-5/8" 33 mil steel studs, 16" o.c. 1" air gap. 3-5/8" 33 mil steel studs, 16" o.c. 3-1/2", R-13 glass fiber insulation friction fit into stud cavity. Base layer: 1-3/8" QuietRock® 545 gypsum panel applied vertically. 2" Type S drywall screws spaced 8" o.c. at edges and 12" o.c. in the field. Face layer: 1-3/8" QuietRock® 545 gypsum panel applied vertically.
Hz	TL							
80	46							
100	52							
<p align="center">Non-Load Bearing Vertical joints staggered on opposite sides</p>		<ul style="list-style-type: none"> 3-1/2" Type S drywall screws spaced 8" o.c. at edges and 12" o.c. in the field. 						











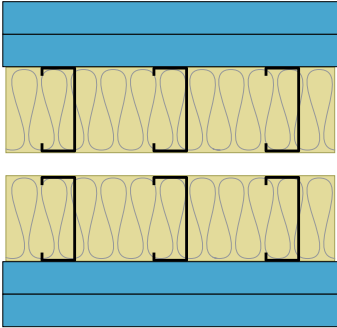



24" o.c.	16" o.c.	Description						
	<p align="center">PGD-33D-155-16</p> <p align="center">STC 72 NOAL 20-0754 – 16" o.c.</p> <p align="center">Low Frequency Transmission Loss</p> <table border="1" data-bbox="565 619 766 697"> <tr> <td>Hz</td> <td>TL</td> </tr> <tr> <td>80</td> <td>40</td> </tr> <tr> <td>100</td> <td>43</td> </tr> </table>  <p align="center">Fire: Non-Rated</p> <p>Thickness: 11" Approx weight: 14.4 lb/ft²</p>	Hz	TL	80	40	100	43	<ul style="list-style-type: none">  2" Type S drywall screws spaced 8" o.c. at edges and 12" o.c. in the field.  One layer: 1-3/8" QuietRock® 545 gypsum panel applied vertically.  3-1/2", R-13 glass fiber insulation friction fit into stud cavity.  3-5/8" 33 mil steel studs, 16" o.c.  1" air gap.  3-5/8" 33 mil steel studs, 16" o.c.  3-1/2", R-13 glass fiber insulation friction fit into stud cavity.  One layer: 1-3/8" QuietRock® 545 gypsum panel applied vertically.
Hz	TL							
80	40							
100	43							
<p align="center">Non-Load Bearing Vertical joints staggered on opposite sides</p>		<ul style="list-style-type: none">  2" Type S drywall screws spaced 8" o.c. at edges and 12" o.c. in the field. 						









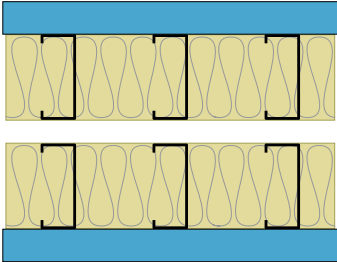

24" o.c.	16" o.c.	Description						
	<p align="center">PGD-33D-265-16</p> <p align="center">STC 66 NOAL 20-0742 – 16" o.c.</p> <p align="center">Low Frequency Transmission Loss</p> <table border="1" data-bbox="565 619 771 697"> <tr> <td>Hz</td> <td>TL</td> </tr> <tr> <td>80</td> <td>31</td> </tr> <tr> <td>100</td> <td>36</td> </tr> </table>  <p align="center">Fire: Non-Rated</p> <p>Thickness: 10-1/4" Approx weight: 10.4 lb/ft²</p>	Hz	TL	80	31	100	36	<ul style="list-style-type: none">  2" Type S drywall screws spaced 8" o.c. at edges and 12" o.c. in the field.  One layer: 1-3/8" QuietRock® 545 gypsum panel applied vertically.  3-1/2", R-13 glass fiber insulation friction fit into stud cavity.  3-5/8" 33 mil steel studs, 16" o.c.  1" air gap.  3-5/8" 33 mil steel studs, 16" o.c.  3-1/2", R-13 glass fiber insulation friction fit into stud cavity.  One layer: 5/8" type X (FLAME CURB®, MOLD CURB® Plus, ABUSE CURB®, PABCO® Impact Resistant, PABCO® Glass Interior, PABCO® Glass Sheathing or PABCO® Gypsum Sheathing) gypsum panel applied vertically.
Hz	TL							
80	31							
100	36							
<p align="center">Non-Load Bearing Vertical joints staggered on opposite sides</p>		<ul style="list-style-type: none">  1-1/4" Type S drywall screws spaced 8" o.c. at edges and 12" o.c. in the field. 						









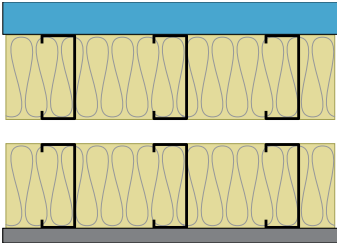

24" o.c.	16" o.c.	Description
	<p align="center">PGD-33D-317-16</p> <p align="center">STC 64</p> <p align="center">NOAL 20-0739 – 16" o.c.</p>  <p align="center">Fire: 1 Hour - UL V464 Configuration C</p> <p>Thickness: 9-1/2" Approx weight: 7.6 lb/ft²</p>	<ul style="list-style-type: none">  1-1/4" Type S drywall screws spaced 8" o.c. at edges and 12" o.c. in the field.  One layer: 5/8" QuietRock® ES or QuietRock® ES MR type X gypsum panel applied vertically.  3-1/2", R-13 glass fiber insulation friction fit into stud cavity.  3-5/8" 33 mil steel studs, 16" o.c.  1" air gap.  3-5/8" 33 mil steel studs, 16" o.c.  3-1/2", R-13 glass fiber insulation friction fit into stud cavity.  One layer: 5/8" QuietRock® ES or QuietRock® ES MR type X gypsum panel applied vertically.
<p align="center">Non-Load Bearing Vertical joints staggered on opposite sides</p>		<ul style="list-style-type: none">  1-1/4" Type S drywall screws spaced 8" o.c. at edges and 12" o.c. in the field.









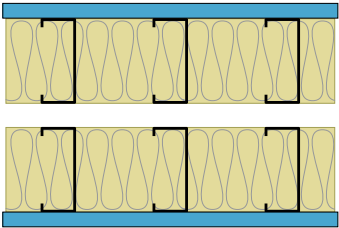

24" o.c.	16" o.c.	Description
	<p align="center">PGD-33D-404-16</p> <p align="center">STC 59</p> <p align="center">NOAL 18-1001 – 16" o.c.</p>  <p align="center">Fire: 1 Hour - UL V464 Configuration C</p> <p align="center">Thickness: 9-1/2" Approx weight: 6.4 lb/ft²</p>	<ul style="list-style-type: none">  1" Type S drywall screws spaced 8" o.c. at edges and 12" o.c. in the field.  One layer: 5/8" type X (FLAME CURB®, MOLD CURB® Plus, ABUSE CURB®, PABCO® Impact Resistant, PABCO® Glass Interior, PABCO® Glass Sheathing or PABCO® Gypsum Sheathing) gypsum panel applied vertically.  3-1/2", R-13 glass fiber insulation friction fit into stud cavity.  3-5/8" 33 mil steel studs, 16" o.c.  1" air gap.  3-5/8" 33 mil steel studs, 16" o.c.  3-1/2", R-13 glass fiber insulation friction fit into stud cavity.  One layer: 5/8" type X (FLAME CURB®, MOLD CURB® Plus, ABUSE CURB®, PABCO® Impact Resistant, PABCO® Glass Interior, PABCO® Glass Sheathing or PABCO® Gypsum Sheathing) gypsum panel applied vertically.
<p align="center">Non-Load Bearing Vertical joints staggered on opposite sides</p>		<ul style="list-style-type: none">  1" Type S drywall screws spaced 8" o.c. at edges and 12" o.c. in the field.









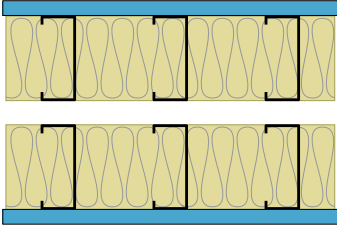

24" o.c.	16" o.c.	Description																
	<p align="center">PGD-54D-105-16</p> <p align="center">STC 83</p> <p align="center">NOAL 21-1214 – 16" o.c.</p> <p align="center">Low Frequency Transmission Loss</p> <table border="1"> <thead> <tr> <th>Hz</th> <th>TL</th> </tr> </thead> <tbody> <tr><td>25</td><td>31</td></tr> <tr><td>31.5</td><td>35</td></tr> <tr><td>40</td><td>41</td></tr> <tr><td>50</td><td>41</td></tr> <tr><td>63</td><td>46</td></tr> <tr><td>80</td><td>52</td></tr> <tr><td>100</td><td>57</td></tr> </tbody> </table>  <p align="center">Fire: Non-Rated</p> <p>Thickness: 18-3/4" Approx weight: 27.0 lb/ft²</p>	Hz	TL	25	31	31.5	35	40	41	50	41	63	46	80	52	100	57	<ul style="list-style-type: none">  3-1/2" Type S drywall screws spaced 8" o.c. at edges and 12" o.c. in the field.  Face layer: 1-3/8" QuietRock® 545 gypsum panel applied vertically.  1-7/8" Type S drywall screws spaced 8" o.c. at edges and 12" o.c. in the field.  Base layer: 1-3/8" QuietRock® 545 gypsum panel applied vertically.  3-1/2", R-13 glass fiber insulation friction fit into stud cavity.  3-5/8" 54 mil steel studs, 16" o.c.  6" air gap.  3-5/8" 54 mil steel studs, 16" o.c.  3-1/2", R-13 glass fiber insulation friction fit into stud cavity.  Base layer: 1-3/8" QuietRock® 545 gypsum panel applied vertically.  1-7/8" Type S drywall screws spaced 8" o.c. at edges and 12" o.c. in the field.  Face layer: 1-3/8" QuietRock® 545 gypsum panel applied vertically.
Hz	TL																	
25	31																	
31.5	35																	
40	41																	
50	41																	
63	46																	
80	52																	
100	57																	
<p align="center">Non-Load Bearing Vertical joints staggered on opposite sides</p>		<ul style="list-style-type: none">  3-1/2" Type S drywall screws spaced 8" o.c. at edges and 12" o.c. in the field. 																









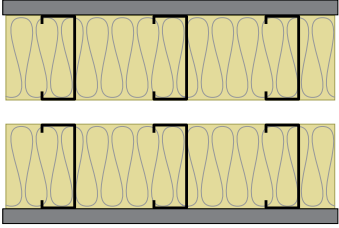

24" o.c.	16" o.c.	Description																
	<p align="center">PGD-54D-147-16</p> <p align="center">STC 80 NOAL 21-1218 – 16" o.c.</p> <p align="center">Low Frequency Transmission Loss</p> <table border="1"> <thead> <tr> <th>Hz</th> <th>TL</th> </tr> </thead> <tbody> <tr><td>25</td><td>28</td></tr> <tr><td>31.5</td><td>32</td></tr> <tr><td>40</td><td>39</td></tr> <tr><td>50</td><td>41</td></tr> <tr><td>63</td><td>45</td></tr> <tr><td>80</td><td>49</td></tr> <tr><td>100</td><td>54</td></tr> </tbody> </table>  <p align="center">Fire: Non-Rated</p> <p>Thickness: 13-3/4" Approx weight: 27.0 lb/ft²</p>	Hz	TL	25	28	31.5	32	40	39	50	41	63	45	80	49	100	54	<ul style="list-style-type: none">  3-1/2" Type S drywall screws spaced 8" o.c. at edges and 12" o.c. in the field.  Face layer: 1-3/8" QuietRock® 545 gypsum panel applied vertically.  1-7/8" Type S drywall screws spaced 8" o.c. at edges and 12" o.c. in the field.  Base layer: 1-3/8" QuietRock® 545 gypsum panel applied vertically.  3-1/2", R-13 glass fiber insulation friction fit into stud cavity.  3-5/8" 54 mil steel studs, 16" o.c.  1" air gap.  3-5/8" 54 mil steel studs, 16" o.c.  3-1/2", R-13 glass fiber insulation friction fit into stud cavity.  Base layer: 1-3/8" QuietRock® 545 gypsum panel applied vertically.  1-7/8" Type S drywall screws spaced 8" o.c. at edges and 12" o.c. in the field.  Face layer: 1-3/8" QuietRock® 545 gypsum panel applied vertically.
Hz	TL																	
25	28																	
31.5	32																	
40	39																	
50	41																	
63	45																	
80	49																	
100	54																	
<p align="center">Non-Load Bearing Vertical joints staggered on opposite sides</p>		<ul style="list-style-type: none">  3-1/2" Type S drywall screws spaced 8" o.c. at edges and 12" o.c. in the field. 																

24" o.c.	16" o.c.	Description																
	<p align="center">PGD-54D-172-16</p> <p align="center">STC 73</p> <p align="center">NOAL 21-1217 – 16" o.c.</p> <p align="center">Low Frequency Transmission Loss</p> <table border="1"> <thead> <tr> <th>Hz</th> <th>TL</th> </tr> </thead> <tbody> <tr><td>25</td><td>21</td></tr> <tr><td>31.5</td><td>26</td></tr> <tr><td>40</td><td>35</td></tr> <tr><td>50</td><td>29</td></tr> <tr><td>63</td><td>37</td></tr> <tr><td>80</td><td>40</td></tr> <tr><td>100</td><td>45</td></tr> </tbody> </table>  <p align="center">Fire: Non-Rated</p> <p>Thickness: 9-1/2"</p> <p>Approx weight: 14.8 lb/ft²</p>	Hz	TL	25	21	31.5	26	40	35	50	29	63	37	80	40	100	45	<ul style="list-style-type: none">  1-7/8" Type S drywall screws spaced 8" o.c. at edges and 12" o.c. in the field.  One layer: 1-3/8" QuietRock® 545 gypsum panel applied vertically.  3-1/2", R-13 glass fiber insulation friction fit into stud cavity.  3-5/8" 54 mil steel studs, 16" o.c.  1" air gap.  3-5/8" 54 mil steel studs, 16" o.c.  3-1/2", R-13 glass fiber insulation friction fit into stud cavity.  One layer: 1-3/8" QuietRock® 545 gypsum panel applied vertically.
Hz	TL																	
25	21																	
31.5	26																	
40	35																	
50	29																	
63	37																	
80	40																	
100	45																	
<p align="center">Non-Load Bearing Vertical joints staggered on opposite sides</p>		<ul style="list-style-type: none">  1-7/8" Type S drywall screws spaced 8" o.c. at edges and 12" o.c. in the field. 																

24" o.c.	16" o.c.	Description						
	<p align="center">PGD-54D-286-16</p> <p align="center">STC 65</p> <p align="center">NOAL 18-0917 – 16" o.c.</p> <p align="center">Low Frequency Transmission Loss</p> <table border="1"> <thead> <tr> <th>Hz</th> <th>TL</th> </tr> </thead> <tbody> <tr> <td>80</td> <td>32</td> </tr> <tr> <td>100</td> <td>41</td> </tr> </tbody> </table>  <p align="center">Fire: Non-Rated</p> <p>Thickness: 10-1/4" Approx weight: 11.3 lb/ft²</p>	Hz	TL	80	32	100	41	<ul style="list-style-type: none">  1-7/8" Type S drywall screws spaced 8" o.c. at edges and 12" o.c. in the field.  One layer: 1-3/8" QuietRock® 545 gypsum panel applied vertically.  3-1/2", R-13 glass fiber insulation friction fit into stud cavity.  3-5/8" 54 mil steel studs, 16" o.c.  1" air gap.  3-5/8" 54 mil steel studs, 16" o.c.  3-1/2", R-13 glass fiber insulation friction fit into stud cavity.  One layer: 5/8" type X (FLAME CURB®, MOLD CURB® Plus, ABUSE CURB®, PABCO® Impact Resistant, PABCO® Glass Interior, PABCO® Glass Sheathing or PABCO® Gypsum Sheathing) gypsum panel applied vertically.
Hz	TL							
80	32							
100	41							
<p align="center">Non-Load Bearing Vertical joints staggered on opposite sides</p>		<ul style="list-style-type: none">  1-1/4" Type S drywall screws spaced 8" o.c. at edges and 12" o.c. in the field. 						

24" o.c.	16" o.c.	Description
	<p>PGD-54D-317-16</p> <p>STC 64 NOAL 18-0920 – 16" o.c.</p>  <p>Fire: 1 Hour - UL V464 Configuration C</p> <p>Thickness: 9-1/2" Approx weight: 8.8 lb/ft²</p>	<ul style="list-style-type: none">  1" Type S drywall screws spaced 8" o.c. at edges and 12" o.c. in the field.  One layer: 5/8" QuietRock® ES or QuietRock® ES MR type X gypsum panel applied vertically.  3-1/2", R-13 glass fiber insulation friction fit into stud cavity.  3-5/8" 54 mil steel studs, 16" o.c.  1" air gap.  3-5/8" 54 mil steel studs, 16" o.c.  3-1/2", R-13 glass fiber insulation friction fit into stud cavity.  One layer: 5/8" QuietRock® ES or QuietRock® ES MR type X gypsum panel applied vertically.
<p>Non-Load Bearing Vertical joints staggered on opposite sides</p>		<ul style="list-style-type: none">  1" Type S drywall screws spaced 8" o.c. at edges and 12" o.c. in the field.

24" o.c.	16" o.c.	Description
	<p data-bbox="570 344 766 373">PGD-54D-394-16</p> <p data-bbox="613 422 722 457">STC 60</p> <p data-bbox="555 466 781 491">NOAL 18-0919 – 16" o.c.</p>  <p data-bbox="516 930 797 989">Fire: 1 Hour - UL V464 Configuration C</p> <p data-bbox="516 1062 751 1121">Thickness: 9-1/2" Approx weight: 8.9 lb/ft²</p>	<ul style="list-style-type: none"> <li data-bbox="878 373 1495 422"> 1" Type S-12 drywall screws spaced 8" o.c. at edges and 12" o.c. in the field. <li data-bbox="878 478 1438 527"> One layer: 5/8" QuietRock® 530 or QuietRock® 530 RF gypsum panel applied vertically. <li data-bbox="878 583 1495 611"> 3-1/2", R-13 glass fiber insulation friction fit into stud cavity. <li data-bbox="878 688 1243 716"> 3-5/8" 54 mil steel studs, 16" o.c. <li data-bbox="878 793 1036 821"> 1" air gap. <li data-bbox="878 898 1243 926"> 3-5/8" 54 mil steel studs, 16" o.c. <li data-bbox="878 1003 1495 1031"> 3-1/2", R-13 glass fiber insulation friction fit into stud cavity. <li data-bbox="878 1108 1438 1136"> One layer: 5/8" QuietRock® 530 or QuietRock® 530 RF gypsum panel applied vertically.
<p data-bbox="289 1184 688 1241">Non-Load Bearing Vertical joints staggered on opposite sides</p>		<ul style="list-style-type: none"> <li data-bbox="878 1184 1495 1232"> 1" Type S-12 drywall screws spaced 8" o.c. at edges and 12" o.c. in the field.

24" o.c.	16" o.c.	Description
	<p align="center">PGD-54D-407-16</p> <p align="center">STC 58 NOAL 18-0914 – 16" o.c.</p>  <p align="center">Fire: 1 Hour - UL V464 Configuration C</p> <p>Thickness: 9-1/2" Approx weight: 7.6 lb/ft²</p>	<ul style="list-style-type: none">  1-1/4" Type S-12 drywall screws spaced 8" o.c. at edges and 12" o.c. in the field.  One layer: 5/8" type X (FLAME CURB®, MOLD CURB® Plus, ABUSE CURB®, PABCO® Impact Resistant, PABCO® Glass Interior, PABCO® Glass Sheathing or PABCO® Gypsum Sheathing) gypsum panel applied vertically.  3-1/2", R-13 glass fiber insulation friction fit into stud cavity.  3-5/8" 54 mil steel studs, 16" o.c.  1" air gap.  3-5/8" 54 mil steel studs, 16" o.c.  3-1/2", R-13 glass fiber insulation friction fit into stud cavity.  One layer: 5/8" type X (FLAME CURB®, MOLD CURB® Plus, ABUSE CURB®, PABCO® Impact Resistant, PABCO® Glass Interior, PABCO® Glass Sheathing or PABCO® Gypsum Sheathing) gypsum panel applied vertically.
<p align="center">Non-Load Bearing Vertical joints staggered on opposite sides</p>		<ul style="list-style-type: none">  1-1/4" Type S-12 drywall screws spaced 8" o.c. at edges and 12" o.c. in the field.

Walls & Interior Partitions

Single Wood Frame

ASSEMBLY COMPONENTS AND PICTOGRAMS

The assemblies in this guide have been divided into sections by framing material type and ordered by design file number. The assembly details are listed in order starting from the outermost layer (attachment); working from top to bottom and ending with the stud or insulation. Pictograms have been added to each assembly detail to provide visual separation of the individual assembly components.

Attachment: identifies screw/nail type, placement, and spacing for attachment of the face layer



Face Layer: identifies the QuietRock product use as a face layer



Attachment: identifies screw/nail type, placement, and spacing for attachment of the face layer



Base Layer: Identifies the PABCO Gypsum product that may be used as a base layer (if applicable)







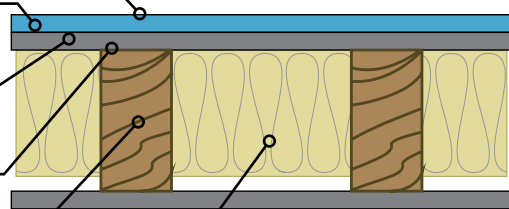

Framing: Identifies stud framing material, size, spacing and/or unique framing methods



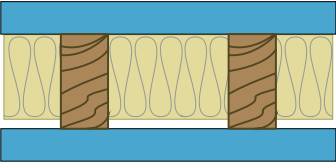
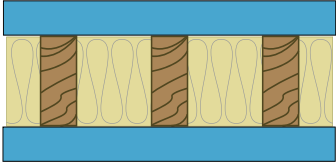







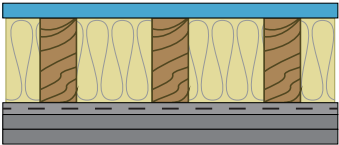

Insulation: Identifies insulation type, size used to fill assembly cavity (if applicable)











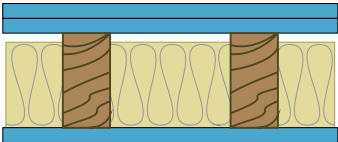

24" o.c.	16" o.c.	Description												
<p align="center">PGD-W-397-24</p> <p align="center">STC 60</p> <p align="center">NRCC TLA-05-048 - 24" o.c.</p> <p>Low Frequency Transmission Loss</p> <table border="0"> <tr> <td>Hz</td> <td>TL</td> </tr> <tr> <td>80</td> <td>28</td> </tr> <tr> <td>100</td> <td>33</td> </tr> </table>  <p>Fire: 1 Hour - UL U309</p> <p>Thickness: 6-1/8" Approx weight: 15.1 lb/ft²</p>	Hz	TL	80	28	100	33	<p align="center">PGD-W-397-16</p> <p align="center">STC 56</p> <p align="center">NOAL 20-0409 - 16" o.c.</p> <p>Low Frequency Transmission Loss</p> <table border="0"> <tr> <td>Hz</td> <td>TL</td> </tr> <tr> <td>80</td> <td>21</td> </tr> <tr> <td>100</td> <td>26</td> </tr> </table>  <p>Fire: 1 Hour - UL U305</p> <p>Thickness: 6-1/8" Approx weight: 13.3 lb/ft²</p>	Hz	TL	80	21	100	26	<ul style="list-style-type: none">  2" Type S or W drywall screws 16" o.c. (for fire 2" screws spaced 8" in perimeter and 12" o.c in the field).  One layer 1-3/8" QuietRock® 545 applied vertically or horizontally.  2 x 4 wood studs 24" o.c. or 16" o.c.  3-1/2", R-13 glass fiber insulation friction fit into stud cavity.  One layer 1-3/8" QuietRock® 545 applied vertically or horizontally.  2" Type S or W drywall screws 16" o.c. (for fire 2" screws spaced 8" in perimeter and 12" o.c in the field).
Hz	TL													
80	28													
100	33													
Hz	TL													
80	21													
100	26													
<p>Load Bearing</p> <p>Vertical joints staggered on opposite sides</p>														











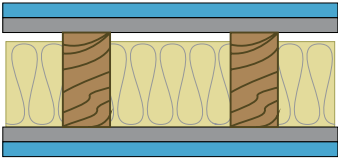

24" o.c.	16" o.c.	Description
	<p data-bbox="581 348 755 375">PGD-W-445-16</p> <p data-bbox="613 520 722 552">STC 57</p> <p data-bbox="558 562 777 590">NOAL 17-0745 - 16" o.c.</p>  <p data-bbox="516 957 764 1016">Fire: 1 Hour - UL U305 GA WP-3114</p> <p data-bbox="516 1058 751 1117">Thickness: 5-7/8" Approx weight: 8.5 lb/ft²</p>	<ul style="list-style-type: none"> <li data-bbox="878 380 1484 426"> 2' Type W drywall screws spaced 7" o.c. (for fire, minimum 1-5/8" screws) <li data-bbox="878 474 1484 520"> One layer 5/8" QuietRock® ES or QuietRock® ES MR Type X gypsum panel applied vertically. <li data-bbox="878 569 1175 615"> 2 x 4 wood studs 16" o.c. <li data-bbox="878 663 1500 709"> 3-1/2", R-13 glass fiber insulation friction fit into stud cavity. <li data-bbox="878 758 1390 804"> Resilient channel applied at right-angle, 24" o.c. <li data-bbox="878 852 1484 898"> 1-1/4 Type W pan head screw attaching Resilient Channel to studs. <li data-bbox="878 947 1500 1045"> Base layer: type X (FLAME CURB®, MOLD CURB® Plus, ABUSE CURB®, PABCO® Impact Resistant, PABCO® Glass Interior, PABCO® Glass Sheathing or PABCO® Gypsum Sheathing) gypsum panel applied horizontally. <li data-bbox="878 1094 1227 1140"> 1" Type S drywall screws 8" o.c. <li data-bbox="878 1188 1500 1266"> Face layer: type X (FLAME CURB®, MOLD CURB® Plus, ABUSE CURB®, PABCO® Impact Resistant, PABCO® Glass Interior, PABCO® Glass Sheathing or PABCO® Gypsum Sheathing) gypsum panel applied horizontally.
<p data-bbox="289 1304 688 1362">Load Bearing Vertical joints staggered on opposite sides</p>		<ul style="list-style-type: none"> <li data-bbox="878 1304 1484 1350"> 2' Type W drywall screws spaced 8" o.c. (for fire, minimum 1-5/8" screws)









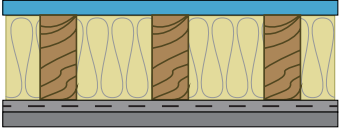

24" o.c.	16" o.c.	Description
<p data-bbox="199 348 370 378">PGD-W-449-24</p> <p data-bbox="228 436 341 470">STC 57</p> <p data-bbox="162 480 410 508">NRCC TLA-04-035 - 24" o.c.</p>  <p data-bbox="133 844 347 869">Fire: 1 Hour - UL U309</p> <p data-bbox="133 911 298 936">Thickness: 5-3/8"</p> <p data-bbox="133 942 370 970">Approx weight: 9.3 lb/ft²</p>		<ul style="list-style-type: none"> <li data-bbox="873 373 1510 436"> 1-5/8" Type S drywall screws spaced 16" o.c. (for fire 2" screws spaced 12" o.c. in the perimeter and 8" o.c. in the field). <li data-bbox="873 474 1510 525"> Face layer: 5/8" QuietRock® 530 or QuietRock® 530 RF type X gypsum panel applied vertically. <li data-bbox="873 562 1510 625"> 2" Type S drywall screws spaced 16" o.c. (for fire 1-5/8" screws spaced 12" o.c. in the perimeter and 8" o.c. in the field). <li data-bbox="873 663 1510 714"> Base layer: 5/8" QuietRock® 530 or QuietRock® 530 RF type X gypsum panel applied vertically. <li data-bbox="873 751 1175 802"> 2 x 4 wood studs 24" o.c. <li data-bbox="873 840 1500 890"> 3-1/2", R-13 glass fiber insulation friction fit into stud cavity. <li data-bbox="873 928 1510 991"> Opposite side One layer: 5/8" QuietRock® 530 or QuietRock® 530 RF type X gypsum panel applied vertically.
<p data-bbox="425 1058 550 1083">Load Bearing</p> <p data-bbox="289 1092 686 1117">Vertical joints staggered on opposite sides</p>		<ul style="list-style-type: none"> <li data-bbox="873 1045 1510 1108"> 1-5/8" Type S drywall screws spaced 16" o.c. (for fire 2" screws spaced 12" o.c. in the perimeter and 8" o.c. in the field).









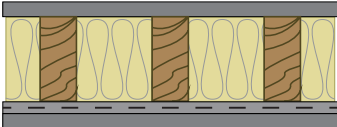

24" o.c.	16" o.c.	Description
<p data-bbox="199 348 371 378">PGD-W-465-24</p> <p data-bbox="228 493 342 527">STC 56</p> <p data-bbox="162 535 410 560">NRCC TLA-04-052 - 24" o.c.</p>  <p data-bbox="134 968 347 993">Fire: 1 Hour - UL U309</p> <p data-bbox="134 1066 261 1092">Thickness: 6"</p> <p data-bbox="134 1100 380 1125">Approx weight: 11.0 lb/ft²</p>		<ul style="list-style-type: none"> <li data-bbox="878 380 1523 428"> 1-5/8" Type S screws spaced 16" o.c. (for fire 1-5/8" drywall screws spaced 12" o.c. in the perimeter and 8" o.c. in the field). <li data-bbox="878 474 1523 522"> Face layer: 5/8" QuietRock® 530 or QuietRock® 530 RF type X gypsum panel applied vertically. <li data-bbox="878 569 1523 617"> 1-5/8" Type S screws spaced 16" o.c. (for fire 1-7/8" Type S drywall screws spaced 7" o.c.). <li data-bbox="878 663 1523 711"> Base layer: 5/8" PABCO Flame Curb® type C gypsum panel applied vertically. <li data-bbox="878 758 1175 806"> 2 x 4 wood studs 24" o.c. <li data-bbox="878 852 1500 900"> 3-1/2", R-13 glass fiber insulation friction fit into stud cavity. <li data-bbox="878 947 1523 995"> Base layer: 5/8" PABCO Frame Curb® type C gypsum panel applied vertically. <li data-bbox="878 1041 1523 1089"> 1-5/8" Type S screws spaced 16" o.c. (for fire 1-7/8" Type S drywall screws spaced 7" o.c.). <li data-bbox="878 1136 1523 1184"> Face layer: 5/8" QuietRock® 530 or QuietRock® 530 RF type X gypsum panel applied vertically.
<p data-bbox="427 1283 553 1308">Load Bearing</p> <p data-bbox="289 1316 688 1341">Vertical joints staggered on opposite sides</p>		<ul style="list-style-type: none"> <li data-bbox="878 1283 1523 1331"> 1-5/8" Type S screws spaced 16" o.c. (for fire 1-5/8" drywall screws spaced 12" o.c. in the perimeter and 8" o.c. in the field).











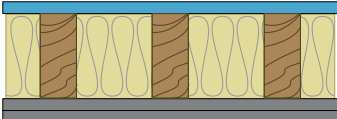





24" o.c.	16" o.c.	Description
	<p data-bbox="581 348 755 378">PGD-W-535-16</p> <p data-bbox="613 428 722 462">STC 53</p> <p data-bbox="557 472 779 499">NOAL 17-0747 - 16" o.c.</p>  <p data-bbox="516 869 730 896">Fire: 1 Hour - UL U305</p> <p data-bbox="516 936 682 963">Thickness: 5-1/4"</p> <p data-bbox="516 968 755 995">Approx weight: 6.4 lb/ft²</p>	<ul style="list-style-type: none"> <li data-bbox="878 380 1485 428"> 2' Type W drywall screws spaced 7" o.c. (for fire, minimum 1-5/8" screws) <li data-bbox="878 474 1485 522"> One layer 5/8" QuietRock® ES or QuietRock® ES MR Type X gypsum panel applied vertically. <li data-bbox="878 569 1177 617"> 2 x 4 wood studs 16" o.c. <li data-bbox="878 663 1502 711"> 3-1/2", R-13 glass fiber insulation friction fit into stud cavity. <li data-bbox="878 758 1388 806"> Resilient channel applied at right-angle, 24" o.c. <li data-bbox="878 852 1510 900"> 1-1/4 Type W pan head screw attaching Resilient Channel to studs. <li data-bbox="878 947 1502 1058"> One layer type X (FLAME CURB®, MOLD CURB® Plus, ABUSE CURB®, PABCO® Impact Resistant, PABCO® Glass Interior, PABCO® Glass Sheathing or PABCO® Gypsum Sheathing) gypsum panel applied horizontally.
<p data-bbox="427 1094 552 1121">Load Bearing</p> <p data-bbox="289 1125 690 1152">Vertical joints staggered on opposite sides</p>		<ul style="list-style-type: none"> <li data-bbox="878 1094 1226 1142"> 1" Type S drywall screws 8" o.c.



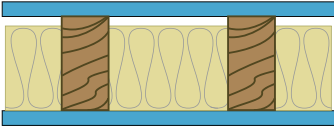
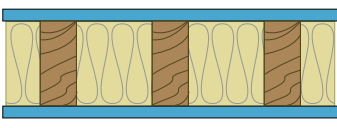





24" o.c.	16" o.c.	Description
	<p data-bbox="581 348 753 378">PGD-W-545-16</p> <p data-bbox="613 457 721 487">STC 48</p> <p data-bbox="558 499 776 529">NOAL 20-0723 - 16" o.c.</p>  <p data-bbox="516 865 766 928">Fire: 1 Hour - UL U305 GA WP-3373</p> <p data-bbox="516 961 750 1024">Thickness: 5-1/4" Approx weight: 5.6 lb/ft²</p>	<ul style="list-style-type: none"> <li data-bbox="880 382 1351 424"> 1-7/8" Type W drywall screws spaced 7" o.c. <li data-bbox="880 466 1497 550"> One layer type X (FLAME CURB®, MOLD CURB® Plus, ABUSE CURB®, PABCO® Impact Resistant, PABCO® Glass Interior, PABCO® Glass Sheathing or PABCO® Gypsum Sheathing) gypsum panel applied horizontally. <li data-bbox="880 592 1172 634"> 2 x 4 wood studs 16" o.c. <li data-bbox="880 697 1497 739"> 3-1/2", R-13 glass fiber insulation friction fit into stud cavity. <li data-bbox="880 802 1383 844"> Resilient channel applied at right-angle, 24" o.c. <li data-bbox="880 907 1497 949"> 1/2" Type W pan head screw attaching Resilient Channel to studs. <li data-bbox="880 991 1497 1075"> One layer type X (FLAME CURB®, MOLD CURB® Plus, ABUSE CURB®, PABCO® Impact Resistant, PABCO® Glass Interior, PABCO® Glass Sheathing or PABCO® Gypsum Sheathing) gypsum panel applied horizontally.
<p data-bbox="289 1129 685 1180">Load Bearing Vertical joints staggered on opposite sides</p>		<ul style="list-style-type: none"> <li data-bbox="880 1129 1237 1171"> 1" Type S drywall screws 12" o.c.



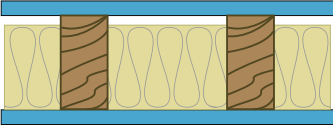
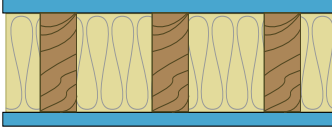





24" o.c.	16" o.c.	Description
	<p align="center">PGD-W-548-16</p> <p align="center">STC 46 NOAL 20-0524 - 16" o.c.</p>  <p align="center">Fire: Non-Rated</p> <p align="center">Thickness: 5" Approx weight: 6.3 lb/ft²</p>	<ul style="list-style-type: none">  1-1/4" type W drywall screws 12" o.c.  One layer 1/2" QuietRock® 510 gypsum panel applied vertically.  2 x 4 wood studs 16" o.c.  3-1/2", R-13 glass fiber insulation friction fit into stud cavity.  Base layer 1/2" PABCO® Litecore® gypsum panel.  1-1/4" Type W screws 12" o.c.  Face layer 1/2" PABCO® Litecore® gypsum panel.
Vertical joints staggered on opposite sides		<ul style="list-style-type: none">  1-7/8" type W drywall screws 12" o.c.

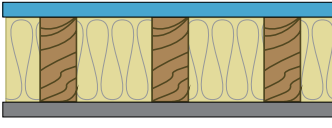





PGD-W-557-24	PGD-W-557-16	
<p align="center">STC 52 RAL-TL-07-022 - 24" o.c.</p>  <p align="center">Fire: Non-Rated</p> <p align="center">Thickness: 4-1/2" Approx weight: 5.4 lb/ft²</p>	<p align="center">STC 45 NOAL 20-0525 - 16" o.c.</p>  <p align="center">Fire: Non-Rated</p> <p align="center">Thickness: 4-1/2" Approx weight: 5.7 lb/ft²</p>	<ul style="list-style-type: none">  1-1/4" type W drywall screws 12" o.c.  One layer 1/2" QuietRock® 510 gypsum panel applied vertically.  2 x 4 wood studs 24" o.c. or 16" o.c.  3-1/2", R-13 glass fiber insulation friction fit into stud cavity.  One layer 1/2" QuietRock® 510 gypsum panel applied vertically.
Vertical joints staggered on opposite sides		<ul style="list-style-type: none">  1-1/4" type W drywall screws 12" o.c.



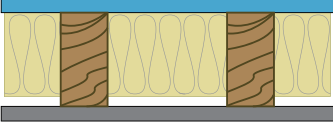
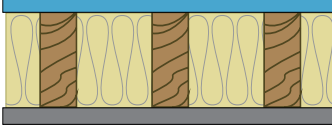





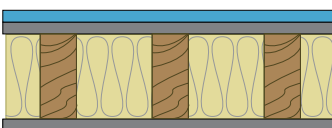

24" o.c.	16" o.c.	Description
<p>PGD-W-574-24</p> <p>STC 51 NOAL 18-0531 - 24" o.c.</p>  <p>Fire: 1 Hour - UL U309</p> <p>Thickness: 4-3/4" Approx weight: 6.3 lb/ft²</p>	<p>PGD-W-574-16</p> <p>STC 45 NOAL 20-0412 - 16" o.c.</p>  <p>Fire: 1 Hour - UL U305 GA WP 3377</p> <p>Thickness: 4-3/4" Approx weight: 6.8 lb/ft²</p>	<ul style="list-style-type: none">  2" Type W drywall screws 8" o.c. (for fire 1-7/8" Type W drywall screws 7" o.c.).  One layer 5/8" QuietRock® ES or QuietRock® ES MR type X gypsum panel applied vertically.  2 x 4 wood studs 24" o.c. or 16"  3-1/2", R-13 glass fiber insulation friction fit into stud cavity.  One layer 5/8" QuietRock® ES or QuietRock® ES MR type X gypsum panel applied vertically.  2" Type W drywall screws 8" o.c. (for fire 1-7/8" Type W drywall screws 7" o.c.).
<p>Load Bearing Vertical joints staggered on opposite sides</p>		









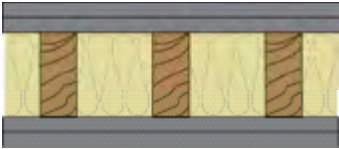

	<p>PGD-W-642-16</p> <p>STC 42 NOAL 20-0523 - 16" o.c.</p>  <p>Fire: Non-Rated</p> <p>Thickness: 4-5/8" Approx weight: 4.9 lb/ft²</p>	<ul style="list-style-type: none">  1-1/4" type W drywall screws spaced 12" o.c.  One layer 1/2" QuietRock® 510 gypsum panel applied vertically.  2 x 4 wood studs 16" o.c.  3-1/2", R-13 glass fiber insulation friction fit into stud cavity.  One layer 1/2" PABCO® Litecore® gypsum panel.  1-1/4" type W drywall screws 12" o.c.
<p>Vertical joints staggered on opposite sides</p>		











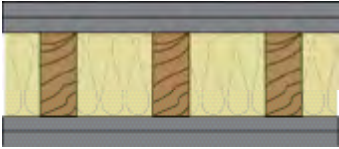

24" o.c.	16" o.c.	Description
<p>PGD-W-646-24</p> <p>STC 47 NOAL 18-0530 - 24" o.c.</p>  <p>Fire: 1 Hour - UL U309</p> <p>Thickness: 4-3/4" Approx weight: 5.8 lb/ft²</p>	<p>PGD-W-646-16</p> <p>STC 41 NOAL 17-0730 - 16" o.c.</p>  <p>Fire: 1 Hour - UL U305</p> <p>Thickness: 4-3/4" Approx weight: 6.3 lb/ft²</p>	<ul style="list-style-type: none">  2" Type W drywall screws 8" o.c. (for fire: U309 & U305 - minimum 1-7/8" drywall screws spaced 7" o.c.).  One layer 5/8" QuietRock® ES or QuietRock® ES MR type X gypsum panel applied vertically.  2 x 4 wood studs 24" o.c. or 16" o.c.  3-1/2", R-13 glass fiber insulation friction fit into stud cavity.  One layer 5/8" Type X (FLAME CURB®, MOLD CURB® Plus, ABUSE CURB®, PABCO® Impact Resistant, PABCO® Glass Sheathing or PABCO® Gypsum Sheathing) gypsum panel applied vertically.  2" Type W drywall screws 7" o.c. (for fire: U309 & U305 - minimum 1-7/8" drywall screws).
<p>Load Bearing Vertical joints staggered on opposite sides</p>		

	<p>PGD-W-648-16</p> <p>STC 41 NOAL 20-0507- 16" o.c.</p>  <p>Fire: Non-Rated</p> <p>Thickness: 5" Approx weight: 6.3 lb/ft²</p>	<ul style="list-style-type: none">  1-7/8" Type W screws 12" o.c.  Face layer: 1/2" QuietRock® 510 gypsum panel applied vertically.  1-1/4" Type W screws 12" o.c.  Base layer: 1/2" PABCO® Litecore® gypsum panel.  2 x 4 wood studs 16" o.c.  3-1/2", R-13 glass fiber insulation friction fit into stud cavity.  One layer 1/2" PABCO® Litecore® gypsum panel.  1-1/4" Type W screws 12" o.c.
<p>Vertical joints staggered on opposite sides</p>		









24" o.c.	16" o.c.	Description
	<p data-bbox="581 352 755 380">PGD-W-824-16</p> <p data-bbox="613 548 722 579">STC 38</p> <p data-bbox="558 590 777 617">NOAL 17-0734 - 16" o.c.</p>  <p data-bbox="516 989 727 1016">Fire: 2 Hour - UL U301</p> <p data-bbox="516 1052 643 1079">Thickness: 6"</p> <p data-bbox="516 1087 751 1115">Approx weight: 9.9 lb/ft²</p>	<ul style="list-style-type: none"> <li data-bbox="878 380 1425 428">  2-1/2" Type W drywall screws spaced 8" o.c. (for fire, minimum 2-3/8" screws) <li data-bbox="878 464 1503 548">  Face layer: type X (FLAME CURB®, MOLD CURB® Plus, ABUSE CURB®, PABCO® Impact Resistant, PABCO® Glass Interior, PABCO® Glass Sheathing or PABCO® Gypsum Sheathing) gypsum panel applied horizontally. <li data-bbox="878 590 1474 638">  2" Type W drywall screws 6" o.c. (for fire, minimum 1-7/8" screws) <li data-bbox="878 674 1503 758">  Base layer: type X (FLAME CURB®, MOLD CURB® Plus, ABUSE CURB®, PABCO® Impact Resistant, PABCO® Glass Interior, PABCO® Glass Sheathing or PABCO® Gypsum Sheathing) gypsum panel applied horizontally. <li data-bbox="878 800 1175 848">  2 x 4 wood studs 16" o.c. <li data-bbox="878 905 1500 953">  3-1/2", R-13 glass fiber insulation friction fit into stud cavity. <li data-bbox="878 989 1503 1073">  Base layer: type X (FLAME CURB®, MOLD CURB® Plus, ABUSE CURB®, PABCO® Impact Resistant, PABCO® Glass Interior, PABCO® Glass Sheathing or PABCO® Gypsum Sheathing) gypsum panel applied horizontally. <li data-bbox="878 1115 1474 1163">  2" Type W drywall screws 6" o.c. (for fire, minimum 1-7/8" screws) <li data-bbox="878 1199 1503 1283">  Face layer: type X (FLAME CURB®, MOLD CURB® Plus, ABUSE CURB®, PABCO® Impact Resistant, PABCO® Glass Interior, PABCO® Glass Sheathing or PABCO® Gypsum Sheathing) gypsum panel applied horizontally.
<p data-bbox="423 1325 553 1352">Load Bearing</p> <p data-bbox="289 1360 688 1388">Vertical joints staggered on opposite sides</p>		<ul style="list-style-type: none"> <li data-bbox="878 1325 1451 1373">  2-1/2" Type W drywall screws 8" o.c. (for fire, minimum 2-3/8" screws)

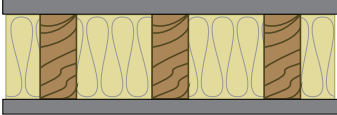







24" o.c.	16" o.c.	Description
	<p data-bbox="581 348 755 378">PGD-W-844-16</p> <p data-bbox="613 541 722 577">STC 37</p> <p data-bbox="557 588 779 615">NOAL 20-0505 - 16" o.c.</p>  <p data-bbox="516 987 673 1014">Fire: Non-Rated</p> <p data-bbox="516 1050 682 1077">Thickness: 5-1/2"</p> <p data-bbox="516 1087 755 1115">Approx weight: 7.0 lb/ft²</p>	<ul style="list-style-type: none"> <li data-bbox="876 384 1356 420"> 1-7/8 Type W drywall screws spaced 12" o.c. <li data-bbox="876 483 1396 518"> Face layer 1/2" PABCO® Litecore® gypsum panel. <li data-bbox="876 594 1356 630"> 1-1/4" Type W drywall screws spaced 12" o.c. <li data-bbox="876 693 1396 728"> Base layer 1/2" PABCO® Litecore® gypsum panel. <li data-bbox="876 804 1177 840"> 2 x 4 wood studs 16" o.c. <li data-bbox="876 909 1502 945"> 3-1/2", R-13 glass fiber insulation friction fit into stud cavity. <li data-bbox="876 1014 1396 1050"> Base layer 1/2" PABCO® Litecore® gypsum panel. <li data-bbox="876 1119 1356 1155"> 1-1/4" Type W drywall screws spaced 12" o.c. <li data-bbox="876 1224 1396 1260"> Face layer 1/2" PABCO® Litecore® gypsum panel.
<p data-bbox="289 1360 690 1388">Vertical joints staggered on opposite sides</p>		<ul style="list-style-type: none"> <li data-bbox="876 1329 1356 1365"> 1-7/8 Type W drywall screws spaced 12" o.c.

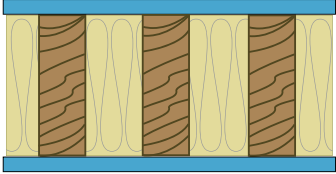









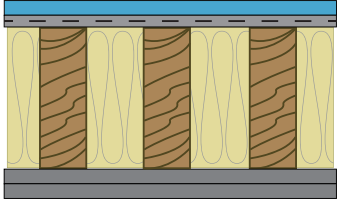

24" o.c.	16" o.c.	Description
	<p data-bbox="581 348 755 375">PGD-W-914-16</p> <p data-bbox="613 392 722 426">STC 34</p> <p data-bbox="558 434 777 459">NOAL 20-0506 - 16" o.c.</p>  <p data-bbox="516 764 673 789">Fire: Non-Rated</p> <p data-bbox="516 831 678 856">Thickness: 4-1/2"</p> <p data-bbox="516 863 751 888">Approx weight: 4.1 lb/ft²</p>	<ul style="list-style-type: none"> <li data-bbox="878 380 1360 422"> 1-1/4" Type W drywall screws spaced 12" o.c. <li data-bbox="878 485 1393 527"> One layer 1/2" PABCO® Litecore® gypsum panel. <li data-bbox="878 590 1175 632"> 2 x 4 wood studs 16" o.c. <li data-bbox="878 695 1500 737"> 3-1/2", R-13 glass fiber insulation friction fit into stud cavity. <li data-bbox="878 821 1393 863"> One layer 1/2" PABCO® Litecore® gypsum panel.
<p data-bbox="289 968 688 993">Vertical joints staggered on opposite sides</p>		<ul style="list-style-type: none"> <li data-bbox="878 957 1360 999"> 1-1/4" Type W drywall screws spaced 12" o.c.











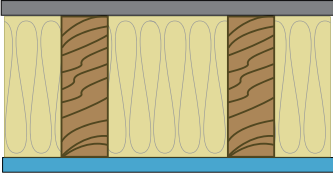





24" o.c.	16" o.c.	Description
<p>PGD-W6-467-24</p> <p>STC 56 NOAL 21-1053 - 24" o.c.</p>  <p>Fire: 1 Hour - UL U309</p> <p>Thickness: 6-3/4" Approx weight: 7.3 lb/ft²</p>	<p>PGD-W6-467-16</p> <p>STC 49 NOAL 21-1047 - 16" o.c.</p>  <p>Fire: 1 Hour - UL V310</p> <p>Thickness: 6-3/4" Approx weight: 7.7 lb/ft²</p>	<ul style="list-style-type: none">  1-5/8" Type S drywall screws spaced 12" o.c. in the perimeter and 8" o.c.  One layer: 5/8" QuietRock® 530 or QuietRock® 530 RF type X gypsum panel applied vertically.  2 x 6 wood studs 24" o.c. or 16" o.c.  6", R-19 glass fiber insulation friction fit into stud cavity.  Opposite side One layer: 5/8" QuietRock® 530 or QuietRock® 530 RF type X gypsum panel applied vertically.  1-5/8" Type S drywall screws spaced 12" o.c. in the perimeter and 8" o.c.
<p>Load Bearing Vertical joints staggered on opposite sides</p>		

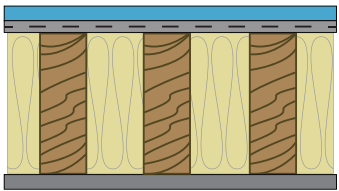









24" o.c.	16" o.c.	Description
	<p data-bbox="574 348 760 380">PGD-W6-485-16</p> <p data-bbox="613 474 721 506">STC 55</p> <p data-bbox="558 516 776 548">NOAL 21-0513 - 16" o.c.</p>  <p data-bbox="516 1052 760 1125">Fire: 1 Hour - UL U305 WFCi 14041 10/3/2014</p> <p data-bbox="516 1167 760 1230">Thickness: 7-7/8" Approx weight: 9.1 lb/ft²</p>	<ul style="list-style-type: none"> <li data-bbox="878 380 1479 432"> 1' Type S drywall screws spaced 8" o.c. (For fire minimum screws spaced 12" o.c.) <li data-bbox="878 474 1479 527"> One layer 5/8" QuietRock® ES or QuietRock® ES MR Type X gypsum panel applied vertically. <li data-bbox="878 569 1390 621"> Resilient channel applied at right-angle, 24" o.c. <li data-bbox="878 684 1479 737"> 1-1/4 Type W pan head screw attaching Resilient Channel to studs. <li data-bbox="878 779 1179 831"> 2 x 6 wood studs, 16" o.c. <li data-bbox="878 894 1495 936"> 6-1/4", R-19 glass fiber insulation friction fit into stud cavity. <li data-bbox="878 978 1479 1073"> Base layer 5/8" Type X (FLAME CURB®, MOLD CURB® Plus, ABUSE CURB®, PABCO® Impact Resistant, PABCO® Glass Sheathing or PABCO® Gypsum Sheathing) gypsum panel applied vertically. <li data-bbox="878 1115 1341 1157"> 1-7/8" Type S drywall screws spaced 7" o.c. <li data-bbox="878 1199 1479 1293"> Face layer 5/8" Type X (FLAME CURB®, MOLD CURB® Plus, ABUSE CURB®, PABCO® Impact Resistant, PABCO® Glass Sheathing or PABCO® Gypsum Sheathing) gypsum panel applied vertically.
<p data-bbox="423 1367 553 1398">Load Bearing</p> <p data-bbox="289 1398 691 1430">Vertical joints staggered on opposite sides</p>		<ul style="list-style-type: none"> <li data-bbox="878 1346 1349 1388"> 2-1/2" Type S drywall screws spaced 7" o.c..

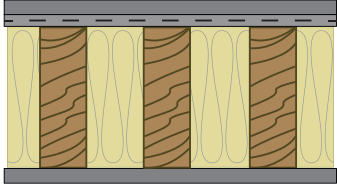









24" o.c.	16" o.c.	Description
<p>PGD-W6-565-24</p> <p>STC 52 NOAL 21-1052 - 24" o.c.</p>  <p>Fire: 1 Hour - UL U309</p> <p>Thickness: 6-3/4" Approx weight: 6.6 lb/ft²</p>		<ul style="list-style-type: none">  1-5/8" Type S drywall screws spaced 12" o.c. at perimeter and 8" o.c. in field.  One layer 5/8" QuietRock® 530 or QuietRock® 530 RF gypsum panel applied vertically.  2 x 6 wood studs 24" o.c.  6-1/4", R-19 glass fiber insulation friction fit into stud cavity.  One layer 5/8" Type X (FLAME CURB®, MOLD CURB® Plus, ABUSE CURB®, PABCO® Impact Resistant, PABCO® Glass Sheathing or PABCO® Gypsum Sheathing) gypsum panel applied vertically.
<p>Load Bearing Vertical joints staggered on opposite sides</p>		<ul style="list-style-type: none">  1-7/8" Type S drywall screws spaced 7" o.c..

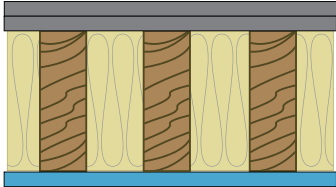





	<p>PGD-W6-595-16</p> <p>STC 50 NOAL 21-0514 - 16" o.c.</p>  <p>Fire: 1 Hour - UL U305</p> <p>Thickness: 7-1/4" Approx weight: 7.0 lb/ft²</p>	<ul style="list-style-type: none">  1' Type S drywall screws spaced 8" o.c. (For fire minimum screws spaced 12" o.c.)  One layer 5/8" QuietRock® ES or QuietRock® ES MR Type X gypsum panel applied vertically.  Resilient channel applied at right-angle, 24" o.c.  1-1/4" Type W pan head screw attaching Resilient Channel to studs.  2 x 6 wood studs 16" o.c.  6-1/4", R-19 glass fiber insulation friction fit into stud cavity.  One layer 5/8" Type X (FLAME CURB®, MOLD CURB® Plus, ABUSE CURB®, PABCO® Impact Resistant, PABCO® Glass Sheathing or PABCO® Gypsum Sheathing) gypsum panel applied vertically.
<p>Load Bearing Vertical joints staggered on opposite sides</p>		<ul style="list-style-type: none">  1-7/8" Type S drywall screws spaced 7" o.c..



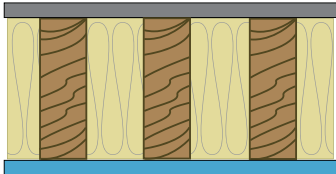







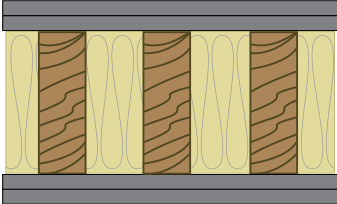

24" o.c.	16" o.c.	Description
	<p data-bbox="574 348 760 378">PGD-W6-625-16</p> <p data-bbox="613 485 721 516">STC 48</p> <p data-bbox="558 527 776 552">NOAL 21-0510 - 16" o.c.</p>  <p data-bbox="516 890 727 915">Fire: 1 Hour - UL U305</p> <p data-bbox="516 989 678 1014">Thickness: 7-1/4"</p> <p data-bbox="516 1020 750 1045">Approx weight: 6.4 lb/ft²</p>	<ul style="list-style-type: none"> <li data-bbox="878 380 1479 426"> 1' Type S drywall screws spaced 8" o.c. (For fire minimum screws spaced 12" o.c.) <li data-bbox="878 464 1479 548"> One layer 5/8" Type X (FLAME CURB®, MOLD CURB® Plus, ABUSE CURB®, PABCO® Impact Resistant, PABCO® Glass Sheathing or PABCO® Gypsum Sheathing) gypsum panel applied vertically. <li data-bbox="878 590 1390 625"> Resilient channel applied at right-angle, 24" o.c. <li data-bbox="878 695 1479 741"> 1-1/4 Type W pan head screw attaching Resilient Channel to studs. <li data-bbox="878 800 1174 835"> 2 x 6 wood studs 16" o.c. <li data-bbox="878 905 1498 940"> 6-1/4", R-19 glass fiber insulation friction fit into stud cavity. <li data-bbox="878 989 1479 1073"> One layer 5/8" Type X (FLAME CURB®, MOLD CURB® Plus, ABUSE CURB®, PABCO® Impact Resistant, PABCO® Glass Sheathing or PABCO® Gypsum Sheathing) gypsum panel applied vertically.
<p data-bbox="423 1161 548 1186">Load Bearing</p> <p data-bbox="289 1192 686 1218">Vertical joints staggered on opposite sides</p>		<ul style="list-style-type: none"> <li data-bbox="878 1146 1344 1182"> 1-7/8" Type S drywall screws spaced 7" o.c.









24" o.c.	16" o.c.	Description
	<p align="center">PGD-W6-672-16</p> <p align="center">STC 46 NOAL 21-0503 - 16" o.c.</p>  <p align="center">Fire: 1 Hour - UL U305 WFCi 14041 10/3/2014</p> <p align="center">Thickness: 7-3/8" Approx weight: 9.0 lb/ft²</p>	<ul style="list-style-type: none">  2-1/2" Type S drywall screws spaced 7" o.c.  Face layer 5/8" Type X (FLAME CURB®, MOLD CURB® Plus, ABUSE CURB®, PABCO® Impact Resistant, PABCO® Glass Sheathing or PABCO® Gypsum Sheathing) gypsum panel applied vertically.  1-7/8" Type S drywall screws spaced 7" o.c.  Base layer 5/8" Type X (FLAME CURB®, MOLD CURB® Plus, ABUSE CURB®, PABCO® Impact Resistant, PABCO® Glass Sheathing or PABCO® Gypsum Sheathing) gypsum panel applied vertically.  2 x 6 wood studs 16" o.c.  6-1/4", R-19 glass fiber insulation friction fit into stud cavity.  One layer 5/8" QuietRock® ES or QuietRock® ES MR Type X gypsum panel applied vertically.
<p align="center">Load Bearing Vertical joints staggered on opposite sides</p>		<ul style="list-style-type: none">  1-1/4" Type S drywall screws spaced 8" o.c.

	<p align="center">PGD-W6-753-16</p> <p align="center">STC 42 NOAL 21-0504 - 16" o.c.</p>  <p align="center">Fire: 1 Hour - UL U305 WFCi 14041 10/3/2014</p> <p align="center">Thickness: 6-3/4" Approx weight: 6.9 lb/ft²</p>	<ul style="list-style-type: none">  1-7/8" Type S drywall screws spaced 7" o.c.  One layer 5/8" Type X (FLAME CURB®, MOLD CURB® Plus, ABUSE CURB®, PABCO® Impact Resistant, PABCO® Glass Sheathing or PABCO® Gypsum Sheathing) gypsum panel applied vertically.  2 x 6 wood studs 16" o.c.  6-1/4", R-19 glass fiber insulation friction fit into stud cavity.  One layer 5/8" QuietRock® ES or QuietRock® ES MR Type X gypsum panel applied vertically.
<p align="center">Load Bearing Vertical joints staggered on opposite sides</p>		<ul style="list-style-type: none">  1-1/4" Type S drywall screws spaced 8" o.c.

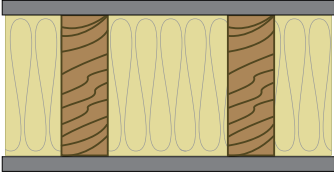
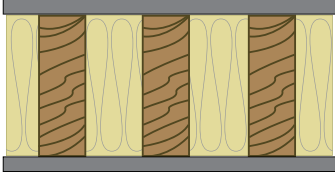

24" o.c.	16" o.c.	Description
	<p data-bbox="574 348 760 373">PGD-W6-824-16</p> <p data-bbox="613 512 721 541">STC 38</p> <p data-bbox="558 554 776 579">NOAL 21-0502 - 16" o.c.</p>  <p data-bbox="516 1050 727 1075">Fire: 1 Hour - UL U305</p> <p data-bbox="516 1117 763 1176">Thickness: 8" Approx weight: 10.5 lb/ft²</p>	<ul style="list-style-type: none"> <li data-bbox="876 378 1347 415">  2-1/2" Type S drywall screws spaced 7" o.c. <li data-bbox="876 462 1477 546">  Face layer 5/8" Type X (FLAME CURB®, MOLD CURB® Plus, ABUSE CURB®, PABCO® Impact Resistant, PABCO® Glass Sheathing or PABCO® Gypsum Sheathing) gypsum panel applied vertically. <li data-bbox="876 588 1347 625">  1-7/8" Type S drywall screws spaced 7" o.c. <li data-bbox="876 672 1477 756">  Base layer 5/8" Type X (FLAME CURB®, MOLD CURB® Plus, ABUSE CURB®, PABCO® Impact Resistant, PABCO® Glass Sheathing or PABCO® Gypsum Sheathing) gypsum panel applied vertically. <li data-bbox="876 798 1169 835">  2 x 6 wood studs 16" o.c. <li data-bbox="876 903 1494 940">  6-1/4", R-19 glass fiber insulation friction fit into stud cavity. <li data-bbox="876 987 1477 1071">  Base layer 5/8" Type X (FLAME CURB®, MOLD CURB® Plus, ABUSE CURB®, PABCO® Impact Resistant, PABCO® Glass Sheathing or PABCO® Gypsum Sheathing) gypsum panel applied vertically. <li data-bbox="876 1113 1347 1150">  1-7/8" Type S drywall screws spaced 7" o.c. <li data-bbox="876 1197 1477 1281">  Face layer 5/8" Type X (FLAME CURB®, MOLD CURB® Plus, ABUSE CURB®, PABCO® Impact Resistant, PABCO® Glass Sheathing or PABCO® Gypsum Sheathing) gypsum panel applied vertically.
<p data-bbox="289 1327 688 1381">Load Bearing Vertical joints staggered on opposite sides</p>		<ul style="list-style-type: none"> <li data-bbox="876 1323 1347 1360">  2-1/2" Type S drywall screws spaced 7" o.c.



24" o.c.	16" o.c.	Description
<p data-bbox="191 352 378 380">PGD-W6-914-24</p> <p data-bbox="228 401 341 434">STC 42</p> <p data-bbox="175 443 394 468">NOAL 21-1051 - 24" o.c.</p>  <p data-bbox="131 806 347 831">Fire: 1 Hour - UL U309</p> <p data-bbox="131 871 298 896">Thickness: 6-3/4"</p> <p data-bbox="131 905 370 930">Approx weight: 6.0 lb/ft²</p>	<p data-bbox="573 352 760 380">PGD-W6-914-16</p> <p data-bbox="610 401 722 434">STC 34</p> <p data-bbox="557 443 776 468">NOAL 21-0501 - 16" o.c.</p>  <p data-bbox="513 806 729 831">Fire: 1 Hour - UL U305</p> <p data-bbox="513 871 680 896">Thickness: 6-3/4"</p> <p data-bbox="513 905 747 930">Approx weight: 6.3 lb/ft²</p>	<ul style="list-style-type: none"> <li data-bbox="873 380 1344 426"> 1-7/8" Type S drywall screws spaced 7" o.c. <li data-bbox="873 464 1479 552"> One layer 5/8" Type X (FLAME CURB®, MOLD CURB® Plus, ABUSE CURB®, PABCO® Impact Resistant, PABCO® Glass Sheathing or PABCO® Gypsum Sheathing) gypsum panel applied vertically. <li data-bbox="873 590 1268 636"> 2 x 6 wood studs 24" o.c. or 16" o.c. <li data-bbox="873 695 1500 741"> 6-1/4", R-19 glass fiber insulation friction fit into stud cavity. <li data-bbox="873 779 1479 867"> One layer 5/8" Type X (FLAME CURB®, MOLD CURB® Plus, ABUSE CURB®, PABCO® Impact Resistant, PABCO® Glass Sheathing or PABCO® Gypsum Sheathing) gypsum panel applied vertically. <li data-bbox="873 947 1344 993"> 1-7/8" Type S drywall screws spaced 7" o.c.
<p data-bbox="423 982 553 1008">Load Bearing</p> <p data-bbox="289 1016 688 1041">Vertical joints staggered on opposite sides</p>		

Walls & Interior Partitions







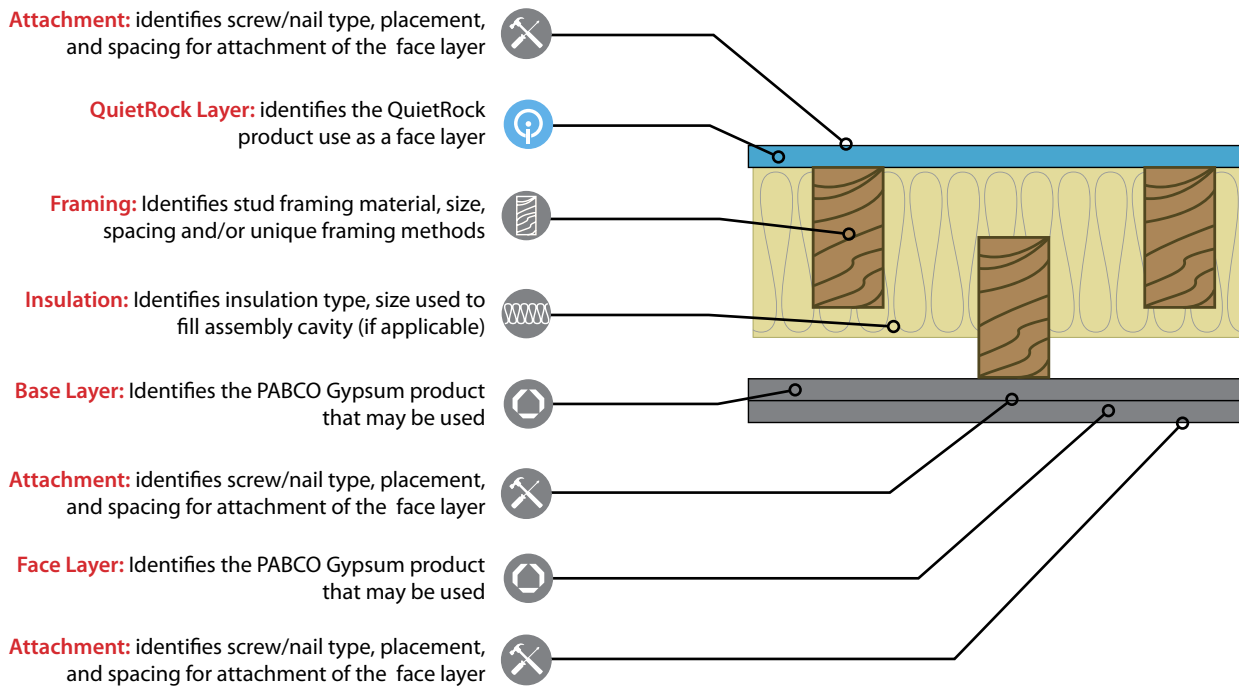

Staggered Wood Frame

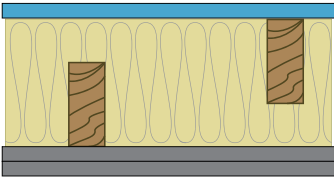
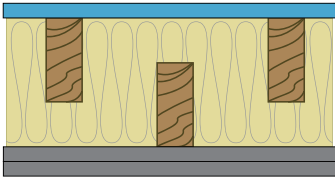
ASSEMBLY COMPONENTS AND PICTOGRAMS







The assemblies in this guide have been divided into sections by framing material type and ordered by design file number. The assembly details are listed in order starting from the outermost layer (attachment); working from top to bottom and ending with the stud or insulation. Pictograms have been added to each assembly detail to provide visual separation of the individual assembly components.



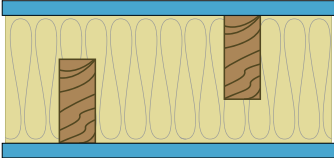
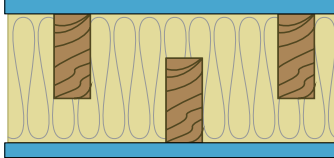









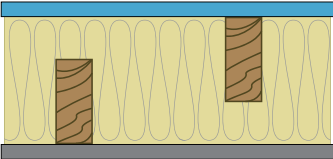
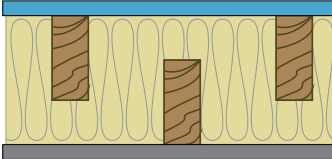



24" o.c.	16" o.c.	Description
<p data-bbox="191 382 378 409">PGD-WS-467-24</p> <p data-bbox="228 443 341 478">STC 56</p> <p data-bbox="175 487 394 512">NOAL 21-0623 - 24" o.c.</p>  <p data-bbox="133 884 347 909">Fire: 1 Hour - UL U340</p> <p data-bbox="133 982 370 1043">Thickness: 7-3/8" Approx weight: 8.8 lb/ft²</p>	<p data-bbox="573 382 760 409">PGD-WS-467-16</p> <p data-bbox="610 443 722 478">STC 53</p> <p data-bbox="557 487 776 512">NOAL 17-0939 - 16" o.c.</p>  <p data-bbox="514 884 729 909">Fire: 1 Hour - UL U340</p> <p data-bbox="514 982 751 1043">Thickness: 7-3/8" Approx weight: 9.4 lb/ft²</p>	<ul style="list-style-type: none"> <li data-bbox="873 411 1484 457"> 1-1/4" Type W drywall screws 8" o.c. (for fire 1-7/8" drywall screws 7" o.c.) <li data-bbox="873 506 1484 552"> One layer 5/8" QuietRock® ES or QuietRock® ES MR type X gypsum panel applied vertically. <li data-bbox="873 600 1255 653"> 2 x 4 wood studs on 2x6 plates: 24" o.c. staggered 12" o.c. or 16" o.c. staggered 8" o.c. <li data-bbox="873 701 1500 741"> 6-1/4", R-19 glass fiber insulation friction fit into stud cavity. <li data-bbox="873 789 1505 877"> Base layer: type X (FLAME CURB®, MOLD CURB® Plus, ABUSE CURB®, PABCO® Impact Resistant, PABCO® Glass Interior, PABCO® Glass Sheathing or PABCO® Gypsum Sheathing) gypsum panel. <li data-bbox="873 926 1386 957"> 1-7/8" Type W bugle head drywall screws 7" o.c. <li data-bbox="873 1005 1505 1094"> Face layer: type X (FLAME CURB®, MOLD CURB® Plus, ABUSE CURB®, PABCO® Impact Resistant, PABCO® Glass Interior, PABCO® Glass Sheathing or PABCO® Gypsum Sheathing) gypsum panel.
<p data-bbox="423 1123 550 1148">Load Bearing</p> <p data-bbox="289 1155 688 1180">Vertical joints staggered on opposite sides</p>		<ul style="list-style-type: none"> <li data-bbox="873 1123 1386 1163"> 2-1/2" Type W bugle head drywall screws 7" o.c.

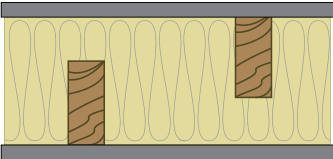
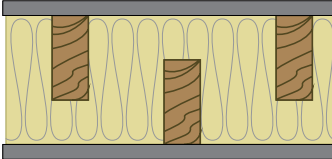

24" o.c.	16" o.c.	Description
<p data-bbox="191 380 378 407">PGD-WS-485-24</p> <p data-bbox="228 457 341 489">STC 55</p> <p data-bbox="172 499 397 525">NOAL 21-0625 - 24" o.c.</p>  <p data-bbox="131 764 347 789">Fire: 1 Hour - UL U340</p> <p data-bbox="131 831 298 856">Thickness: 6-3/4"</p> <p data-bbox="131 863 370 888">Approx weight: 7.4 lb/ft²</p>	<p data-bbox="573 380 760 407">PGD-WS-485-16</p> <p data-bbox="610 457 722 489">STC 55</p> <p data-bbox="553 499 779 525">NOAL 17-0942 - 16" o.c.</p>  <p data-bbox="513 764 730 789">Fire: 1 Hour - UL U340</p> <p data-bbox="643 800 764 825">GA WP-3113</p> <p data-bbox="513 831 680 856">Thickness: 6-3/4"</p> <p data-bbox="513 863 751 888">Approx weight: 8.0 lb/ft²</p>	<ul style="list-style-type: none"> <li data-bbox="873 411 1484 457">  1-1/4" Type W drywall screws 8" o.c. (for fire 1-7/8" drywall screws 7" o.c.) <li data-bbox="873 506 1484 552">  One layer 5/8" QuietRock® ES or QuietRock® ES MR type X gypsum panel applied vertically. <li data-bbox="873 600 1256 646">  2 x 4 wood studs on 2x6 plates: 24" o.c. staggered 12" o.c. or 16" o.c. staggered 8" o.c. <li data-bbox="873 695 1500 741">  6-1/4", R-19 glass fiber insulation friction fit into stud cavity. <li data-bbox="873 831 1484 877">  One layer 5/8" QuietRock® ES or QuietRock® ES MR type X gypsum panel applied vertically.
<p data-bbox="423 951 553 976">Load Bearing</p> <p data-bbox="289 982 688 1008">Vertical joints staggered on opposite sides</p>		<ul style="list-style-type: none"> <li data-bbox="873 951 1484 997">  1-1/4" Type W drywall screws 8" o.c. (for fire 1-7/8" drywall screws 7" o.c.)



24" o.c.	16" o.c.	Description
<p>PGD-WS-537-24</p> <p>STC 53 NOAL 21-0624 - 24" o.c.</p>  <p>Fire: 1 Hour - UL U340</p> <p>Thickness: 6-3/4"</p> <p>Approx weight: 6.8 lb/ft²</p>	<p>PGD-WS-537-16</p> <p>STC 51 NOAL 17-0940 - 16" o.c.</p>  <p>Fire: 1 Hour - UL U340 GA WP-3263</p> <p>Thickness: 6-3/4"</p> <p>Approx weight: 7.3 lb/ft²</p>	<ul style="list-style-type: none">  1-1/4" Type W drywall screws 8" o.c. (for fire 1-7/8" drywall screws 7" o.c.)  One layer 5/8" QuietRock® ES or QuietRock® ES MR type X gypsum panel applied vertically.  2 x 4 wood studs on 2x6 plates: 24" o.c. staggered 12" o.c. or 16" o.c. staggered 8" o.c.  6-1/4", R-19 glass fiber insulation friction fit into stud cavity.  One layer 5/8" Type X (FLAME CURB®, MOLD CURB® Plus, ABUSE CURB®, PABCO® Impact Resistant, PABCO® Glass Interior, PABCO® Glass Sheathing or PABCO® Gypsum Sheathing) gypsum panel applied vertically.  1*-7/8" Type W bugle head drywall screws 7" o.c.
<p>Load Bearing Vertical joints staggered on opposite sides</p>		

<p>PGD-WS-647-24</p> <p>STC 47 NOAL 21-0621 - 16" o.c.</p>  <p>Fire: 1 Hour UL U340</p> <p>Thickness: 6-3/4"</p> <p>Approx weight: 6.1 lb/ft²</p>	<p>PGD-WS-647-16</p> <p>STC 47 NOAL 17-0936 - 16" o.c.</p>  <p>Fire: 1 Hour UL U340</p> <p>Thickness: 6-3/4"</p> <p>Approx weight: 6.7 lb/ft²</p>	<ul style="list-style-type: none">  1-7/8" Type W bugle head drywall screws 7" o.c.  One layer: 5/8" Type X (FLAME CURB®, MOLD CURB® Plus, ABUSE CURB®, PABCO® Impact Resistant, PABCO® Glass Interior, PABCO® Glass Sheathing or PABCO® Gypsum Sheathing) gypsum panel applied vertically.  2 x 4 wood studs on 2x6 plates: 24" o.c. staggered 12" o.c. or 16" o.c. staggered 8" o.c.  6", R-19 glass fiber insulation friction fit into stud cavity.  One layer: 5/8" Type X (FLAME CURB®, MOLD CURB® Plus, ABUSE CURB®, PABCO® Impact Resistant, PABCO® Glass Interior, PABCO® Glass Sheathing or PABCO® Gypsum Sheathing) gypsum panel applied vertically.  1-7/8" Type W bugle head drywall screws 7" o.c.
<p>Load Bearing Vertical joints staggered on opposite sides</p>		

Walls & Interior Partitions







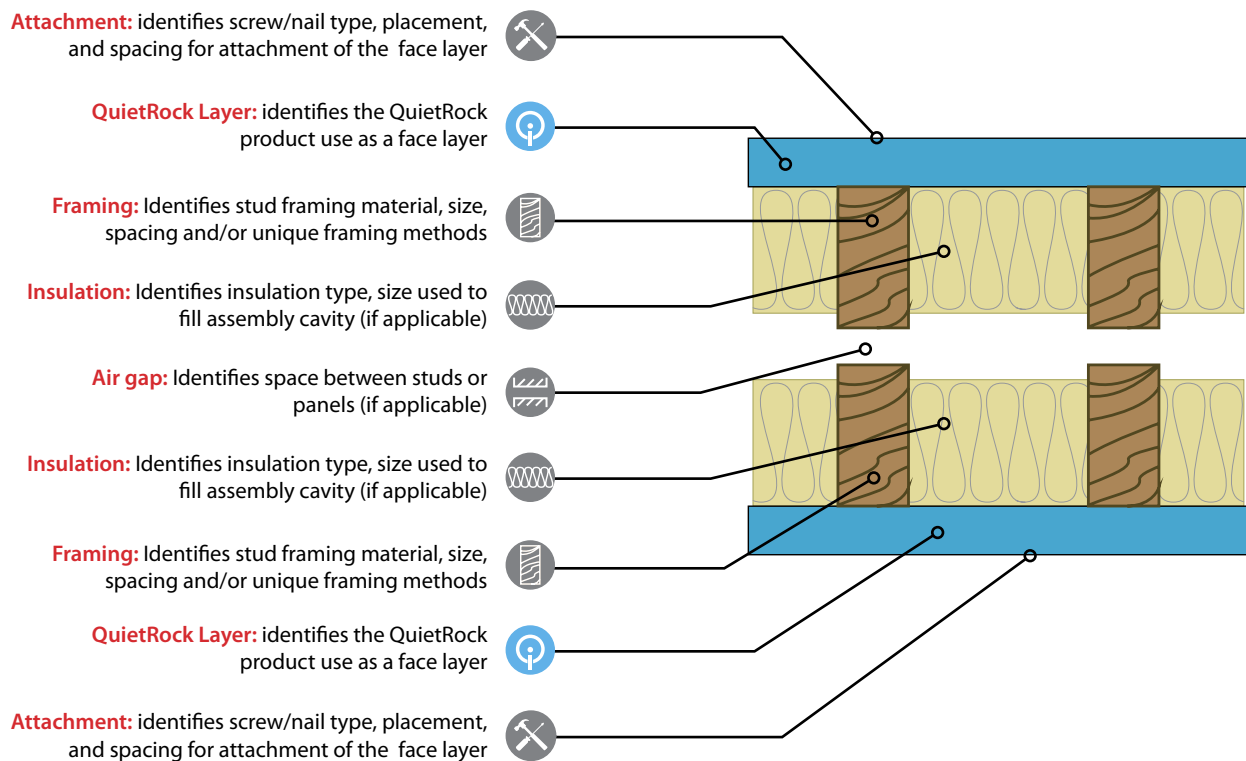



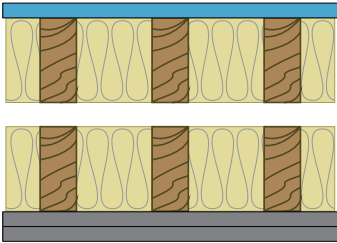

Double Wood Frame

ASSEMBLY COMPONENTS AND PICTOGRAMS









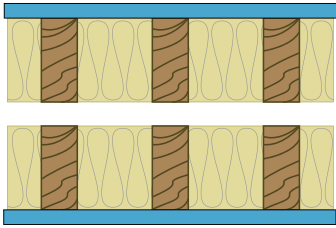

The assemblies in this guide have been divided into sections by framing material type and ordered by design file number. The assembly details are listed in order starting from the outermost layer (attachment); working from top to bottom and ending with the stud or insulation. Pictograms have been added to each assembly detail to provide visual separation of the individual assembly components.













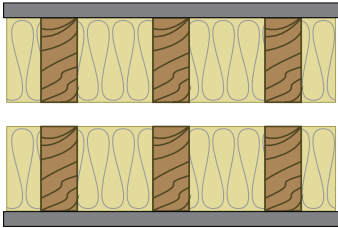

24" o.c.	16" o.c.	Description
	<p data-bbox="573 352 764 380">PGD-WD-354-16</p> <p data-bbox="613 506 724 541">STC 62</p> <p data-bbox="557 548 781 575">NOAL 17-1111 - 16" o.c.</p>  <p data-bbox="516 1079 764 1136">Fire: 1 Hour - UL U341 GA WP-3011</p> <p data-bbox="516 1178 753 1234">Thickness: 9-7/8" Approx weight: 9.8 lb/ft²</p>	<ul style="list-style-type: none"> <li data-bbox="878 380 1511 428"> 1-1/4" Type W drywall screws 8" o.c. (for fire, minimum 1-7/8" screws spaced 7" o.c.) <li data-bbox="878 474 1484 522"> One layer 5/8" QuietRock® ES or QuietRock® ES MR type X gypsum panel applied vertically. <li data-bbox="878 569 1175 617"> 2 x 4 wood studs 16" o.c. <li data-bbox="878 674 1500 722"> 3-1/2", R-13 glass fiber insulation friction fit into stud cavity. <li data-bbox="878 779 1040 827"> 1" air gap. <li data-bbox="878 884 1500 932"> 3-1/2", R-13 glass fiber insulation friction fit into stud cavity. <li data-bbox="878 989 1175 1037"> 2 x 4 wood studs 16" o.c. <li data-bbox="878 1073 1484 1163"> Base layer: 5/8" Type X (FLAME CURB®, MOLD CURB® Plus, ABUSE CURB®, PABCO® Impact Resistant, PABCO® Glass Interior, PABCO® Glass Sheathing or PABCO® Gypsum Sheathing) gypsum panel applied vertically. <li data-bbox="878 1199 1430 1247"> 2" Type W bugle head drywall screws 7" o.c. (for fire, minimum 1-7/8" screws spaced 7" o.c.) <li data-bbox="878 1283 1484 1373"> Face layer: 5/8" Type X (FLAME CURB®, MOLD CURB® Plus, ABUSE CURB®, PABCO® Impact Resistant, PABCO® Glass Interior, PABCO® Glass Sheathing or PABCO® Gypsum Sheathing) gypsum panel applied vertically.
<p data-bbox="289 1409 688 1465">Load Bearing Vertical joints staggered on opposite sides</p>		<ul style="list-style-type: none"> <li data-bbox="878 1409 1430 1457"> 2" Type W bugle head drywall screws 8" o.c. (for fire, minimum 2-1/2" screws spaced 7" o.c.)



24" o.c.	16" o.c.	Description
	<p data-bbox="573 348 764 378">PGD-WD-373-16</p> <p data-bbox="613 394 721 426">STC 61</p> <p data-bbox="557 436 777 464">NOAL 21-0740 - 16" o.c.</p>  <p data-bbox="516 968 727 993">Fire: 1 Hour - UL U341</p> <p data-bbox="516 1066 751 1125">Thickness: 9-1/4" Approx weight: 8.3 lb/ft²</p>	<ul style="list-style-type: none"> <li data-bbox="878 380 1511 428"> 1-1/4" Type W drywall screws 8" o.c. (for fire, minimum 1-7/8" screws spaced 7" o.c.) <li data-bbox="878 474 1479 522"> One layer 5/8" QuietRock® ES or QuietRock® ES MR type X gypsum panel applied vertically. <li data-bbox="878 569 1170 617"> 2 x 4 wood studs 16" o.c. <li data-bbox="878 674 1495 722"> 3-1/2", R-13 glass fiber insulation friction fit into stud cavity. <li data-bbox="878 779 1040 827"> 1" air gap. <li data-bbox="878 884 1495 932"> 3-1/2", R-13 glass fiber insulation friction fit into stud cavity. <li data-bbox="878 989 1170 1037"> 2 x 4 wood studs 16" o.c. <li data-bbox="878 1094 1479 1142"> One layer 5/8" QuietRock® ES or QuietRock® ES MR type X gypsum panel applied vertically.
<p data-bbox="289 1188 688 1245">Load Bearing Vertical joints staggered on opposite sides</p>		<ul style="list-style-type: none"> <li data-bbox="878 1188 1511 1236"> 1-1/4" Type W drywall screws 8" o.c. (for fire, minimum 1-7/8" screws spaced 7" o.c.)



24" o.c.	16" o.c.	Description
	<p data-bbox="574 352 764 380">PGD-WD-468-16</p> <p data-bbox="613 428 725 464">STC 56</p> <p data-bbox="558 470 781 497">NOAL 17-1107 - 16" o.c.</p>  <p data-bbox="516 1001 729 1029">Fire: 1 Hour - UL U341</p> <p data-bbox="516 1066 683 1094">Thickness: 9-1/4"</p> <p data-bbox="516 1100 753 1127">Approx weight: 7.0 lb/ft²</p>	<ul style="list-style-type: none"> <li data-bbox="878 380 1430 428">  2" Type W bugle head drywall screws 7" o.c. (for fire, minimum 1-7/8" screws) <li data-bbox="878 464 1479 552">  One layer: 5/8" type X (FLAME CURB®, MOLD CURB® Plus, ABUSE CURB®, PABCO® Impact Resistant, PABCO® Glass Interior, PABCO® Glass Sheathing or PABCO® Gypsum Sheathing) gypsum panel applied vertically. <li data-bbox="878 588 1175 636">  2 x 4 wood studs 16" o.c. <li data-bbox="878 693 1503 741">  3-1/2", R-13 glass fiber insulation friction fit into stud cavity. <li data-bbox="878 798 1040 846">  1" air gap. <li data-bbox="878 903 1503 951">  3-1/2", R-13 glass fiber insulation friction fit into stud cavity. <li data-bbox="878 1008 1175 1056">  2 x 4 wood studs 16" o.c. <li data-bbox="878 1092 1479 1180">  One layer: 5/8" type X (FLAME CURB®, MOLD CURB® Plus, ABUSE CURB®, PABCO® Impact Resistant, PABCO® Glass Interior, PABCO® Glass Sheathing or PABCO® Gypsum Sheathing) gypsum panel applied vertically.
<p data-bbox="428 1220 553 1247">Load Bearing</p> <p data-bbox="293 1253 688 1281">Vertical joints staggered on opposite sides</p>		<ul style="list-style-type: none"> <li data-bbox="878 1220 1430 1268">  2" Type W bugle head drywall screws 7" o.c. (for fire, minimum 1-7/8" screws)

Walls & Interior Partitions

Area Separation Walls

ASSEMBLY COMPONENTS AND PICTOGRAMS

The assemblies in this guide have been divided into sections by framing material type and ordered by design file number. The assembly details are listed in order starting from the outermost layer (attachment); working from top to bottom and ending with the stud or insulation. Pictograms have been added to each assembly detail to provide visual separation of the individual assembly components.

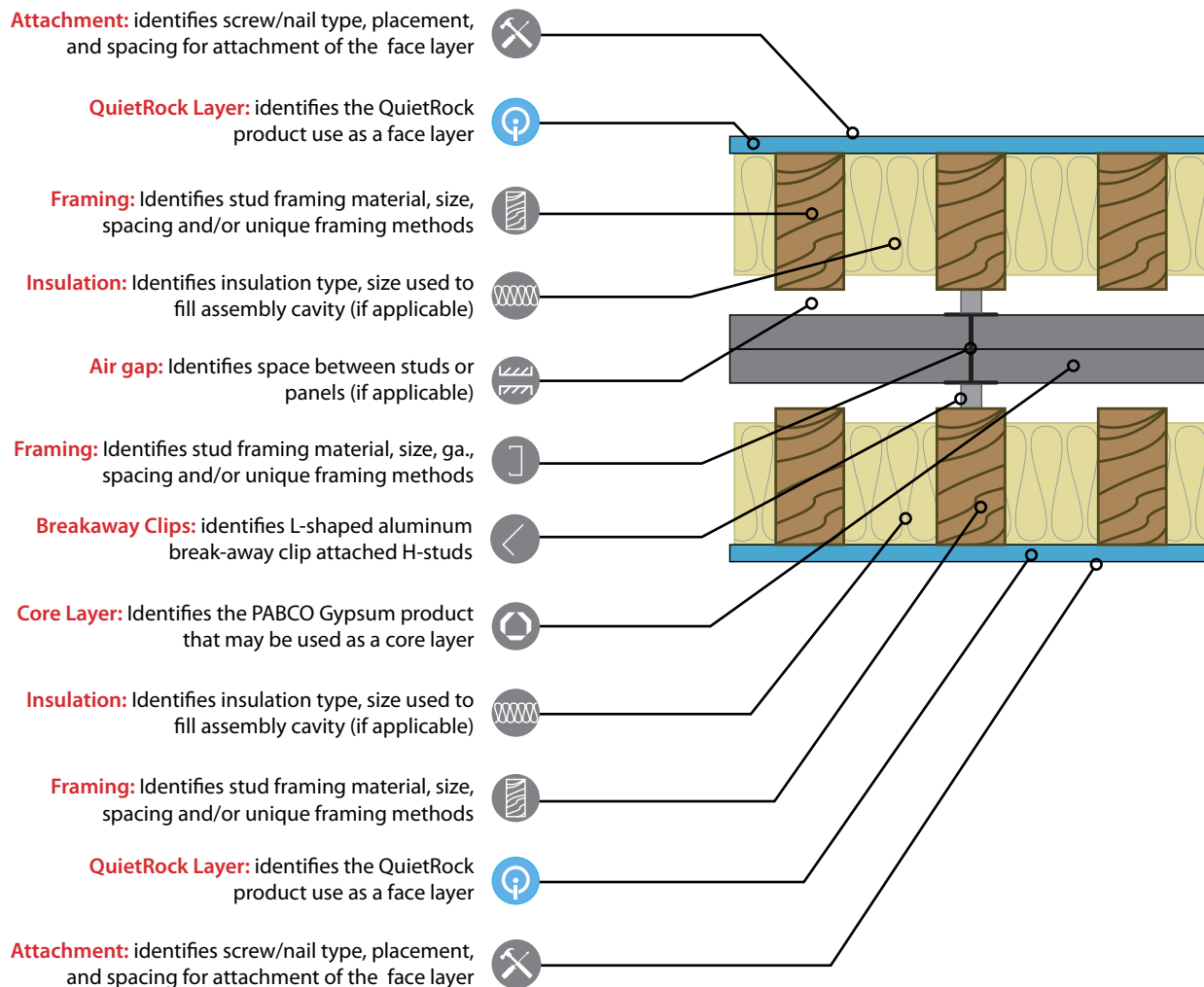

Introduction to The QuietRock® Area Separation Wall System

The unique design of multifamily, multi-storied townhouses and condominiums requires special methods of construction that will provide fire resistance and acoustical separation between dwelling units. The **QuietRock** H-Stud Area Separation Wall System (**QR ASW**) has been developed to meet these critical design criteria.

Weighing no more than nine pounds per square foot when erected, the QR ASW provides a code compliant, efficient, **light-weight** and **low-cost** solution for separating **townhouses**, **condos** and other **multi-family** dwelling units by eliminating the necessity of costly footers and foundation modifications. An important benefit of the QR ASW is that it may be easily erected directly onto a poured concrete slab by the contractor already on site. Carpenters can **easily install** the QR ASW modular system progressively once the framing for one residence is completed and prior to the construction of the adjacent unit. The popularity of the non-load bearing gypsum board QR ASW has grown as contractors and architects discover the efficiency, simplicity and cost effectiveness of the system.

The QR ASW is a two-hour fire resistance rated assembly specifically designed to protect the occupants in attached multi-unit residences. Extending continuously from the foundation to, or through the roof, the QR ASW provides sufficient structural stability under fire conditions to allow collapse of construction on either side without the collapse of the wall.











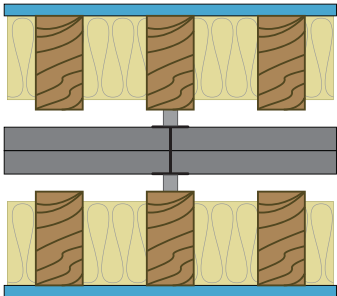



The key benefit of utilizing ½" QuietRock® 510 as the face layers of the assembly increases the **acoustical performance** to a tested and confirmed STC 69 - one of the **thinnest**, **lightest** and highest acoustically tested Area Separation Wall Assemblies designed.

Other components of the QR ASW is a continuous double layer of 1-inch thick, type X, non-combustible PABCORE® Shaftliner or PABCO GLASS® Shaftliner panels installed in a continuous assembly from the foundation to the roof, and from the front to the back wall. This construction restricts the spread of fire while maintaining sufficient structural stability under fire conditions to allow collapse of construction on either side without the collapse of the QR ASW or compromising structural integrity. Structural support is provided by steel C-Runners and H-Studs. Horizontal structural support is provided by L-Shaped "breakaway" aluminum slips, as described in the following section. Depending upon the application, the QR ASW may be extended beyond the roof to form a parapet, or may terminate at the roof level. Shaftliner panels and metal components are easily stacked to allow progressive construction of the QR ASW during the framing stages of the building.

ALUMINUM BREAKAWAY CLIPS allow for the collapse of the structure on the fire-exposed side without collapse of the entire wall or compromising its structural integrity. The QR ASW assembly is attached to each unit's structural framework using L-Shaped aluminum "breakaway" clips fastened to each side of the QR ASW's steel H-Studs and to the structure of each unit. The L-Shaped aluminum clips connect each H-Stud on both sides at the adjacent floors and roof/ceiling intersections to keep the area separation in place between the two structures. The L-Shaped aluminum clips are designed to soften and yield to the heat of the fire at approximately 1,100°F. When one side is exposed to fire, the clips on the exposed fire side soften and breakaway allowing the structure on the exposed fire side to collapse. Because temperatures on the unexposed side of the QR ASW will be far below the point at which the clip will soften, the aluminum clips will remain intact allowing the QR ASW to remain intact and in place, thus protecting the adjacent townhouse.

QuietRock Assemblies Area Separation Wall



24" o.c.	16" o.c.	Description
	<p data-bbox="548 348 784 375">PGD-ASW-W-200-16</p> <p data-bbox="610 583 722 617">STC 69</p> <p data-bbox="553 630 779 653">RAL-TL-07-119 - 16" o.c.</p>  <p data-bbox="513 1159 769 1182">Fire: 2 Hour - WFCi 19045a</p> <p data-bbox="513 1260 691 1283">Thickness: 11-3/4"</p> <p data-bbox="513 1291 763 1314">Approx weight: 15.3 lb/ft²</p>	<ul style="list-style-type: none"> <li data-bbox="873 380 1398 415"> 1-5/8" Type S or W drywall screws spaced 16" o.c. <li data-bbox="873 470 1354 520"> One layer 1/2" QuietRock® 510 gypsum panel applied vertically. <li data-bbox="873 548 1114 583"> 2 x 4 studs 16" o.c. <li data-bbox="873 646 1500 682"> 3-1/2", R-13 glass fiber insulation friction fit into stud cavity. <li data-bbox="873 751 1170 787"> 3/4" minimum air space. <li data-bbox="873 856 1503 907"> Two layers 1" x 24" PABCORE® Gypsum Shaftliner, or PABCO® Glass Shaftliner Type X. <li data-bbox="873 955 1495 1018"> Inserted between 2" 25ga C Track floor and ceiling runners with 2" steel H studs between adjacent pairs of gypsum panels. <li data-bbox="873 1052 1511 1157"> L-shaped aluminum break-away clips are attached to each side of every H-stud (two per stud) with two (2) 1/2" Type S pan head screw through the short leg of the clip. Secure the long leg of the clip to wood framing with one 1-1/4" Type W screw. <li data-bbox="873 1205 1170 1241"> 3/4" minimum air space. <li data-bbox="873 1289 1114 1325"> 2 x 4 studs 16" o.c. <li data-bbox="873 1388 1500 1423"> 3-1/2", R-13 glass fiber insulation friction fit into stud cavity. <li data-bbox="873 1478 1430 1528"> One layer 1/2" QuietRock® 510 gypsum panel applied vertically.
<p data-bbox="423 1577 553 1600">Load Bearing</p> <p data-bbox="289 1610 688 1633">Vertical joints staggered on opposite sides</p> <p data-bbox="134 1642 846 1665">Contact PABCO Tech Services for proper clip attachment for wall height</p>		<ul style="list-style-type: none"> <li data-bbox="873 1598 1398 1633"> 1-5/8" Type S or W drywall screws spaced 16" o.c.



QUIET® IS THE BEST MEDICINE

A pleasant acoustic environment can help support healing. Create a quieter healthcare environment by designing walls with high STC ratings reducing noise transmission between critical spaces such as patient, consultation and treatment rooms.

STOP the **SOUND** transfer with **QUIETROCK®** the original and most technically advanced **SOUND REDUCING DRYWALL** that architects trust, and installers swear by.

[Scan here to learn more](#)



QuietRock®
by PABCO Gypsum

- High acoustic performance
- Easy installation
- Fire/sound-rated performance in one design
- Impact, Mold Resistant, RF Shielding options
- STC not affected by mounted fixtures
- Certified low VOC per CDPH standard

Gypsum Panel Orientation

Horizontal vs vertical vs railroaded installation

HORIZONTAL AND VERTICAL INSTALLATION

Most often gypsum panels are installed in a vertical orientation, meaning the board length runs from floor to ceiling. This is best practice for both sound and fire since there is usually no horizontal joint (butt joint) through the wall.

There are instances when builders prefer to “railroad” panels in corridors (Chase Walls) so that ductwork penetrations in the plenum spaces can be addressed more efficiently or in healthcare facilities to accommodate wiring, plumbing and other devices into headwall fixtures.

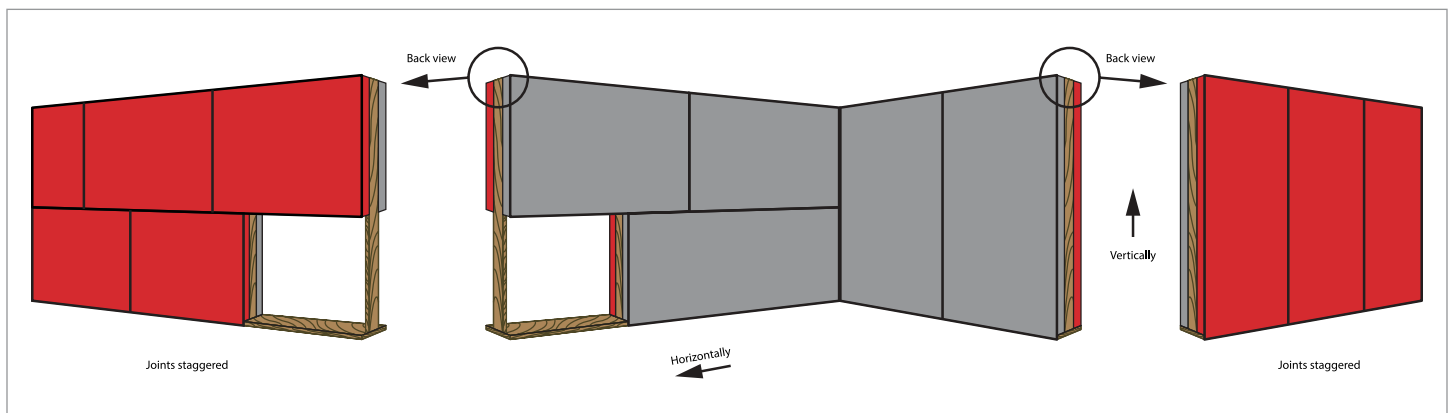

RAILROAD INSTALLATION

Installing gypsum panels horizontally in a “railroad” fashion is becoming a more common practice as builders look for creative ways to manage cost on the job. This technique of lining up panels horizontally on either side of the studs is believed to cut labor costs and decrease production time tables.

A railroad install is one in which the panels are installed horizontally – the length of the board goes across the wall, creating horizontal joint not

backed by a stud and vertical butt joints if the boards do not span the entire length of the wall. In addition to the horizontal orientation, the board joints are not staggered on opposite sides of the wall. Although this practice is not considered best practice, it is an acceptable application method when the assembly is fully fire tested for this application.

Not all gypsum products are approved for this type of an installation. **QuietRock® ES is currently the only internally damped panel that has passed full fire and hose stream tests required for a railroad installation.**

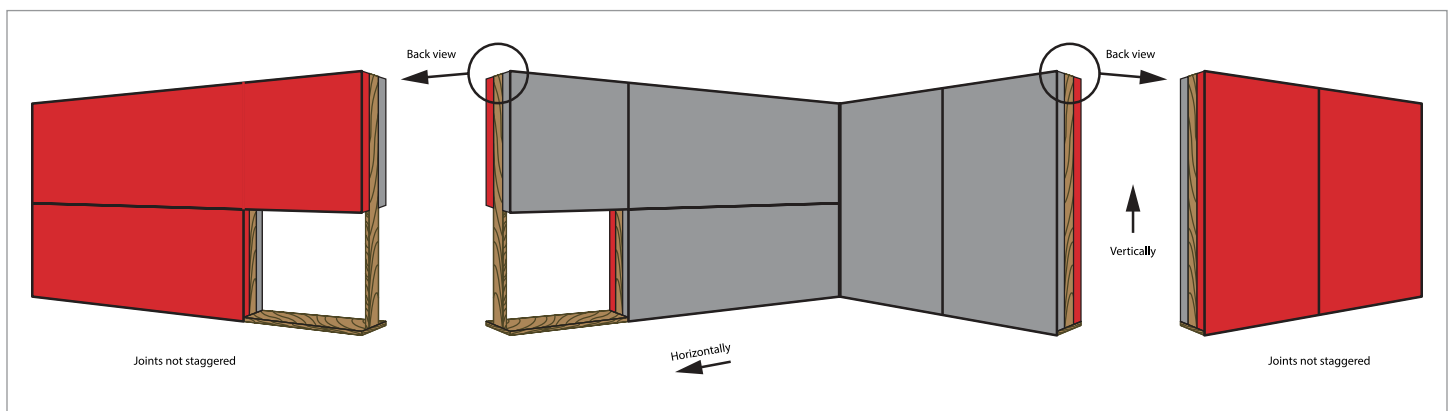

Alternate Fasteners

Substituting screws for nails



So what do you do when you discover that the fire test was done with nails and the sound test was done with screws?

The International Code Council (ICC) has issued an Evaluation Report (ESR-1338, Section 4.2.3.2 Alternate Gypsum Board Fasteners) that allow the substitution of screws for nails in fire rates assemblies provided that the screws meet the following criteria:

1. The screw penetration into the framing member is equivalent to the nail penetration
2. The screw spacing is the same as the nail spacing
3. The cross-sectional area of the screws is equal to that of the specified nails.

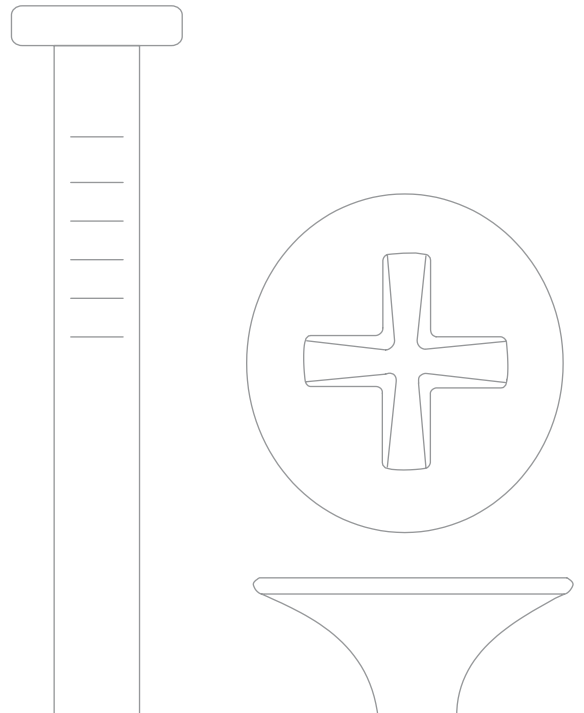
Based on information supplied by nail manufacturer, and drywall screw Manufacturer data supplied below, the 6D nail can be substituted for a #8 type W drywall screw.



Nail 					Screw 			
Size	Gauge	Shank Diameter	Shaft Length	Head Diameter	Size	Body Diameter	Length	Head Diameter
3D	14	0.083"	1-1/4"	1/4"	#6	0.103-0.108"	1-1/4"	0.315-0.335"
4D	12	0.109"	1-1/2"	1/4"	#7	0.112-0.117"	1-1/2"	0.315-0.335"
5D	12	0.109"	1-3/4"	1/4"	#7	0.112-0.117"	1-3/4"	0.315-0.335"
6D	11	0.12"	2"	17/64"	#8	0.121-0.126"	2"	0.315-0.335"

Individual manufacturer specifications may vary, please verify your selection based on the known products available in your area.

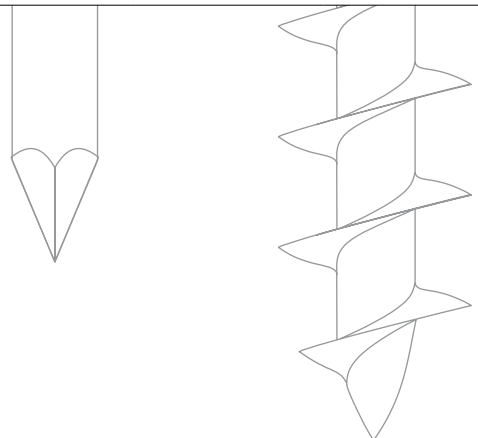

Fire Protection

FIRE RESISTIVE PROPERTIES OF GYPSUM:

Gypsum is approximately 21 percent by weight chemically combined water which greatly contributes to its effectiveness as a fire resistive barrier. When gypsum board or gypsum plaster is exposed to fire, the water is slowly released as steam, effectively retarding heat transmission. It can, in a sense, be compared to what happens when a blowtorch is turned on a block of ice. Although the ice is being melted, one can hold a hand on the opposite side without being burned. Even though the ice gets very thin it effectively blocks the transfer of the intense heat and one's hand would not be burned until the ice is melted.

When gypsum-protected wood or steel structural members are exposed to a fire, the chemically combined water (being released as steam) acts as a thermal barrier until this slow process, known as calcination, is completed. The temperature directly behind the plane of calcination is only slightly higher than that of boiling water (212°F), which is significantly lower than the temperature at which steel begins losing strength or wood ignites. Once calcination is complete, the in-place calcined gypsum continues to act as a barrier protecting the underlying structural members from direct exposure to flames.

TYPE X GYPSUM BOARD

ASTM C1396 describes two types of gypsum board - regular and type X - each providing a different degree of fire resistance. Where fire-resistance rated systems are specified, type X gypsum board is typically required to achieve the rating. Type X gypsum board is defined in ASTM C1396 as gypsum board that provides not less than one-hour fire resistance for boards 5/8 inch thick or not less than 3/4-hour fire-resistance rating for boards 1/2 inch thick, applied parallel with and on each side of load bearing 2x4 wood studs spaced 16 inches on center with 6d coated nails, 17/8 inch long, 0.095 inch diameter shank, 1/4 inch diameter heads, spaced 7 inches on center with gypsum board joints staggered 16 inches on each side of the partition and tested in accordance with the requirements of ASTM E119.

In order to qualify for use in this Guide the Gypsum Association requires that 1/2 inch type X gypsum board shall achieve a one-hour fire-resistance rating when applied to a floor-ceiling system as described by GA File Number FC5410.

We incorporate herein by reference all notes and instructions contained in the GA-600 Fire Design Guide.

FIRE RESISTANCE TESTS

All fire-resistance classifications described in this Guide are derived from full-scale fire tests conducted in accordance with the requirements of ASTM E119 or CAN/ULC-S101 (as amended and in effect on the date of the test) by recognized independent laboratories.

Fire-resistance classifications are the results of tests conducted on systems made up of specific materials put together in a specified manner. There are a number of nationally recognized laboratories capable of conducting tests to establish fire-resistance classifications according to the procedures outlined in ASTM E119 or CAN/ULC-S101. The conditions under which tests are conducted are thoroughly detailed and the fire-resistance classification is established as the time at which there is excessive temperature rise, passage of flame, or structural collapse. In addition, failure may result because of penetration by the pressurized hose stream required in the fire test procedure for walls.

With reference to all tested systems, ASTM E119 states: It is the intent that classifications shall register performance during the period of exposure and shall not be construed as having determined suitability for use after fire exposure.

Comprehensive research by fire protection experts has determined the average combustible content normally present within any given occupancy. In addition, evacuation times, the time required for the contents to be consumed by fire, and the resulting temperature rise have been quantified. Fire-resistance requirements are established accordingly in building codes and similar regulations.

In ASTM E119 fire tests, wall, ceiling, column, and beam systems are exposed in a furnace which reaches the indicated average temperatures at the time stated in the standard time-temperature curve (Figure 1) and Appendix X1 of ASTM E119. The unexposed surface of all systems refers to the surface away from the fire during a test. The exposed surface refers to the surface facing the fire.

WALL AND PARTITION SYSTEMS

All walls and partitions tested and classified are required to be at least 100 square feet in area with no edge dimension less than nine feet. Surface temperatures on the unexposed side of the test specimen are measured at a minimum of nine locations.

When load-bearing walls and partitions are tested, the applied load is required to simulate the working stresses of the design. Walls and partitions are required to stop flame or hot gases capable of igniting cotton waste. The average temperature of the unexposed surface is not permitted to increase more than 250°F above ambient nor is any individual thermocouple permitted to rise more than 325°F above ambient. A duplicate of the system (rated for one-hour fire resistance or more) is fire tested for one-half the specified fire-resistance period, but no longer than one-hour, after which it is required to withstand the impact, erosion, and cooling effect of a hose stream.

Openings in walls for fire door frames and fire window frames shall be coordinated between the architect, the general contractor, the drywall



contractor, and the frame supplier to ensure that installation details for the wall and the frame are considered. The installation instructions supplied with frames vary and shall be followed to comply with local code requirements. All fire door and fire window assemblies are required to be installed in accordance with ANSI/NFPA 80 and subject also to the conditions, limitations, and/or allowances of their certification label and listing.

Figure 1 - Standard Time-Temperature Curve (ASTM E119)

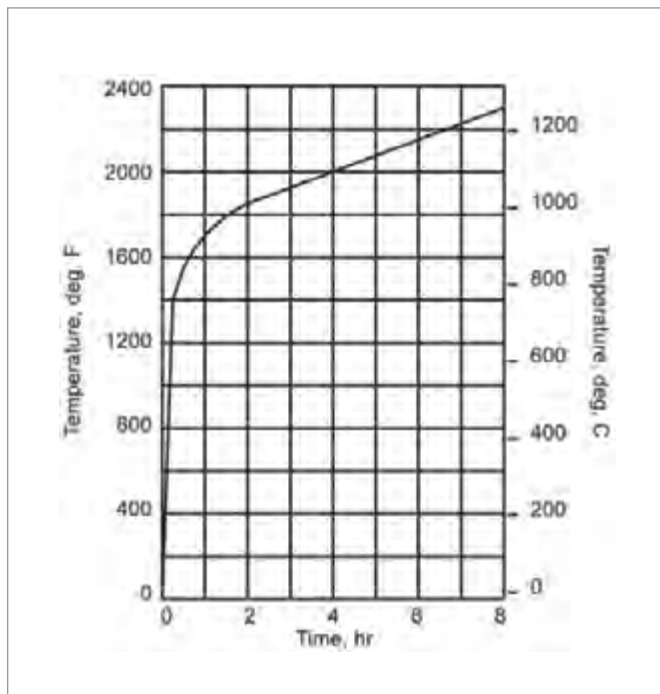

AREA SEPARATION FIRE WALLS (PARTY/FIRE WALLS)

Fire-resistance rated gypsum board systems (solid and cavity types) can serve as area separation fire walls (also known as party walls or fire walls) between adjacent wood frame and steel frame dwelling units such as townhouses, condominiums, and apartments; and in commercial and institutional buildings. These walls are erected one floor at a time, beginning at the foundation and continuing up to or through the roof. At intermediate floors metal floor/ceiling track shall be installed back-to-back to secure the top of the lower section of the partition to the bottom of the next section being installed.

At intermediate floors and other specified locations the area separation fire walls shall be attached to adjacent wood or steel framing on each side with aluminum clips that soften when exposed to fire (Figure 2). If one side of the structure becomes involved in a fire, the clips on the fire side allow collapse of the structure on that side. The clips on the other side support the area separation fire wall keeping it in place, thereby protecting the adjacent structure. Consult PABCO® Gypsum Technical Services and the PABCO® Gypsum Area Separations Wall Guide for clip detail, placement, and height limitations. Openings and through penetrations, including protected openings and penetrations, are not permitted in the area separation fire walls contained in this Guide.

Figure 2 - Typical Gypsum Board Area Separation Fire Wall Construction

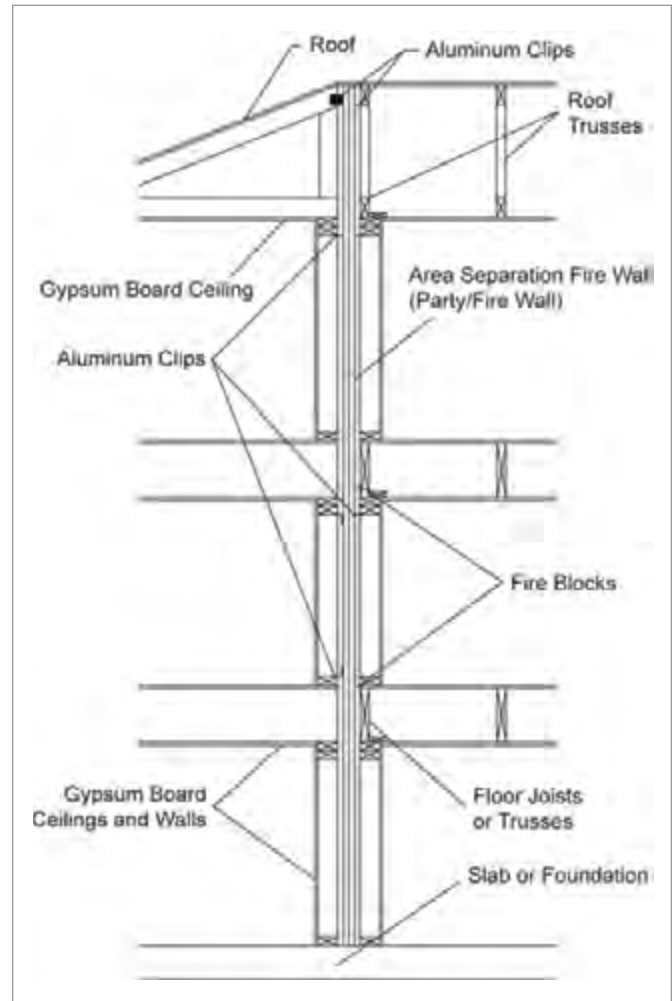

CEILING OPENINGS

Many fire-resistance rated floor-ceiling systems have been tested with openings through the ceiling membrane for air ducts, electrical outlets, and lighting fixtures.

Building codes permit air duct openings in most ceiling systems when the air duct openings are protected with approved ceiling dampers. Building codes also permit membrane penetrations in maximum two-hour fire-resistance-rated horizontal systems by steel outlet boxes that do not exceed 16 square inches in area provided the aggregate area of such penetrations does not exceed 100 square inches in any 100 square feet of ceiling area and the annular space between the ceiling membrane and the box does not exceed 1/8 inch.

Many approved recessed lighting fixtures require special protection. Consult the fire test report or listing for the specific system for protection details and the opening area limitation.



SMOKE BARRIERS

Building codes require certain designated wall and ceiling systems to function as “smoke barriers” which are defined in the codes as continuous membranes that resist the passage of smoke. Fire-resistive gypsum systems with perimeters and penetrations sealed to achieve listed STCs also function to resist the passage of smoke.

Minimum one-hour fire-resistance rated gypsum board systems with joints finished in accordance with Level 1 as specified in GA-214 and perimeters, openings, and penetrations sealed as required by the applicable building code satisfy building code requirements for a smoke barrier.

SURFACE BURNING CHARACTERISTICS

The test method used to establish surface burning characteristics is ASTM E84 or CAN/ULC-S102, commonly referred to as the Tunnel Test. This test measures the relative flame spread and relative amount of smoke generated by the material being tested when compared to inorganic reinforced cement board and red oak flooring. The table below lists typical surface burning characteristics for gypsum products as well as the standard materials referenced in the test method.

Surface burning characteristics are intended to be used as a guide in the selection and use of interior finish materials and are obtained under controlled laboratory conditions for requirements.

SURFACE BURNING CHARACTERISTICS		
Material	Flame Spread	Smoke Developed
Inorganic Reinforced Cement Board	0	0
Gypsum Plaster Glass Mat Gypsum Substrate for Use as Sheathing	0	0
Fiber Reinforced Gypsum Panels	5	0
Gypsum Lath	10	0
Exterior Gypsum Soffit Board	15	0
Gypsum Wallboard Gypsum Sheathing	15	0
Water-Resistant Gypsum Backing Board	15	0
Red Oak	100	100

Refer to the GA-600 for a more in depth discussion on fire controlled systems.

Glossary

Common terminology and definitions

ABSORPTION

Energy dissipation in materials wherein the energy is transferred into rather than reflected from or transmitted through the material. When a sound wave comes in contact with a surface, part of the acoustic energy is “absorbed” into the material and transferred into very small amounts of heat. The amount of absorbed sound energy is proportional to the amount of energy reflected back from the surface. This is not to be confused with **sound transmission**, which only characterizes the amount of sound energy transmitted through the surface.

In general, soft or porous materials absorb more sound energy than smooth, rigid materials. The absorption of specific materials is characterized by the absorption coefficient. The amount of sound absorption within a room can be quantified by the absorption area of the room surfaces, or the total absorption area. Absorption area is calculated from the room dimensions and the absorption coefficients of each of the room surfaces, and is particularly useful in the design of concert halls and recording studios.

ACOUSTICS

1. Physics. The category of physical phenomena associated with sound and sound waves.
2. The characteristics, measurements, and metrics applied to building structures that determine the audibility, fidelity, intelligibility, and comfort levels of the sound within.

ACOUSTICAL SEALANT

Any material (caulking, putty, or liquid) designed for application to a surface or fissure in order to form a resilient (non-hardening) barrier, thereby reducing the risk of sound leakage through penetrations or gaps in assembly partitions.

COINCIDENCE FREQUENCY

The frequency at which the acoustic wave number of the incident sound wave matches the structural wave number of the surface (panel, plate, beam, or string). It can usually be observed in STC reports where there is sudden drop in a sound transmission loss (STL) curve—normally at high frequencies—that would have otherwise followed a relatively linear path.

CONSTRAINED-LAYER DAMPING (CLD)

A vibration isolation technique that employs the application of materials that are viscoelastic—materials that can deform easily when stressed and then return back into their original form—between rigid plates or panels. The resulting composite panel uses shear-loading and vibration decay to reduce noise by 10 dB or more versus traditional treatments. **QuietRock** is an example of a constrained-layer damping (CLD) panel.

DAMPING

Any mechanism that causes dissipation, or loss, in energy.

Damping is not to be confused with dampening, which means “to make wet”.

DECIBEL (dB)

A base-ten logarithmic— \log_{10} , thus the “deci” in the unit name—ratio that is normally calculated as the ratio between measured energy and a reference energy value. For most building noise control measurements the decibel is calculated as 20 times the base-ten logarithm of the ratio between the measured sound pressure and a reference sound pressure (20 μ Pa). Decibels are logarithmic, not linear. Therefore, decibel levels of two different sound sources cannot be added linearly ($2+2=4$). For example,
 $80 \text{ dB} + 80 \text{ dB} = 83 \text{ dB}$.

DECOUPLING

The separation of mechanically- or structurally-coupled systems so that they may operate—or in regard to acoustics, vibrate—independently. Decoupling common to the building noise control industry involves mechanically isolating the gypsum wallboard from the structural members via materials such as resilient channels or sound isolation clips.

EXTENSIONAL DAMPING

Extensional damping is achieved by applying a surface damping compound, such as QuietCoat® to a nonporous metal or plastic substrate.

FIELD MEASUREMENT

Measurements made on-site in rooms or buildings instead of a laboratory. Some examples of field building noise measurements include:

ISPL – Impact Sound Pressure Level is a measurement of the impact noise transmitted from one floor to another

RTNISPL – Reverberation Time Normalized Impact Sound Pressure Level is a measurement of the impact sound pressure level that is normalized based on a reverberation time of 0.5 seconds.

ANISPL – Absorption Normalized Impact Sound Pressure Level is a measurement of the impact sound pressure level that is normalized based on the average absorption area of the test room.

NR – Noise Reduction is a measurement of the sound transmission loss through partitions without accounting for reverberation time, absorption, and flanking paths

NNR – Normalized Noise Reduction is a measurement of the sound transmission loss through partitions that is normalized based on a reverberation times of 0.5 seconds

ATL – Apparent Transmission Loss is a measurement of the sound transmission loss through partitions that is normalized based on the average absorption area of the test room



FTL – Field Transmission loss is a measurement of the sound transmission loss through partitions wherein all possible flanking paths and sound leakage points are treated before measurement and wherein the measurement is normalized based on average absorption area of the test room

FIELD METRICS

Calculations from measured data that normally result in a single-number rating used for characterizing materials, structures, and other physical phenomena. Field building noise control metrics attempt to characterize the performance of an installed building partition. Field metrics are not calculated based on the data measured in laboratories. Examples of field metrics used to characterize building noise control include:

ISR – Impact Sound Reduction is calculated from the ISPL measurement by fitting the ISR contour curve to the ISPL measurement data

NISR – Normalized Impact Sound Reduction is calculated from the RTNISPL measurement by fitting the NISR contour curve to the RTNISPL measurement data

AiIC – Apparent Impact Insulation Class is calculated from the ANISPL measurement by fitting the AiIC contour curve to the ANISPL measurement data

NiC – Noise Isolation Class is calculated from the NR measurement by fitting the NiC contour curve to the NR measurement data

NNiC – Normalized Noise Isolation Class is calculated from the NNR measurement by fitting the NNiC contour curve to the NNR measurement data

ASTC – Apparent Sound Isolation Class is calculated from the ATL measurement by fitting the ASTC contour curve to the ATL measurement data

FSTC – Field Sound Transmission Class is calculated from the FTL measurement by fitting the FSTC contour curve to the FTL measurement data

FLANKING

Passing around. As with sound, a flanking path is the indirect transmission of sound around a partition of interest, frequently through building elements such as adjacent wall partitions, open plenum ceilings, window mullions, and HVAC ducts.

FREE-LAYER DAMPING

See **Extensional Damping**.

FREQUENCY

Frequency is measured as the number of wave oscillations per second. The unit for frequency is Hertz (Hz). A 1 Hz wave oscillates only once per second. Frequency is the property of a sound wave related to its pitch. The audible frequency range for humans is 20 Hz to 20,000 Hz (20 kHz).

GAUGE

A unit of measure of sheet metal or wire. For sheet metal, the scale is retrogressive (higher gauge means lower thickness) and starts with 10-gauge representing a thickness of 0.1345 inches. As the gauge number increases the thickness decreases by 10%.

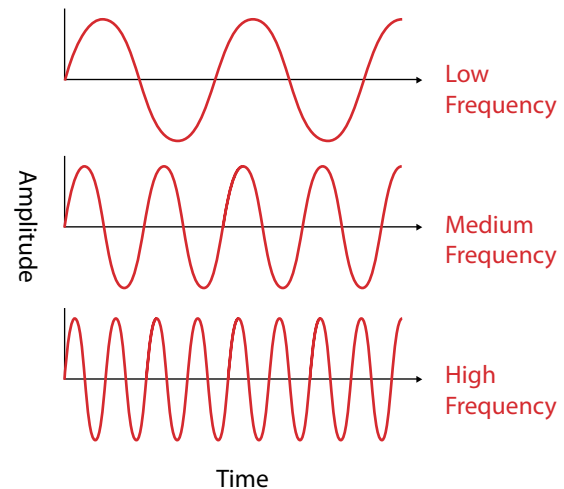

LAB METRICS

Similar to Field Metrics except that the data is collected in a controlled laboratory environment and not in the field. Examples of laboratory metrics used to characterize materials and assemblies for building noise control include:

IIC – Impact Insulation Class is calculated from the Normalized Impact Sound Pressure Level (NISPL), the impact sound pressure level measured in a laboratory and normalized based on the absorption of a standard room, by fitting the NISPL data to the IIC contour curve

STC – Sound Transmission Class is calculated from the STL by fitting the STL data to the STC contour curve

LEAKAGE

The loss of all or part of a useful agent. In the case of sound leakage, it is the flow of sound through an insulator or assembly component, typically via a crack or untreated segment of a wall, a wall penetration or through a flanking path. Sound leakage can most often be eliminated with acoustic caulking, or putty around perimeters, joints or other penetrations.

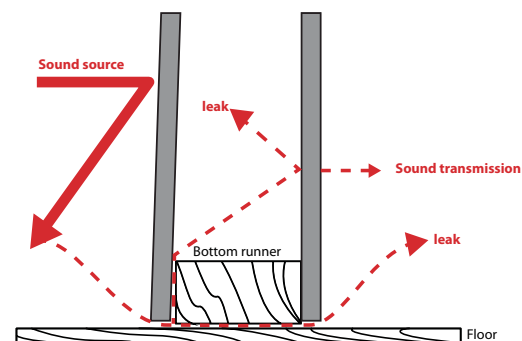

LOUDNESS

How we perceive fluctuations in the amplitude of sound pressure waves, measured in phons or sones. Loudness levels do not directly result from microphone **sound pressure level (SPL)** measurements themselves. Instead, the SPL at each distinct frequency is matched to an equal-loudness contour. Equal-loudness contours are data curves spanning the audible frequency range. Each curve varies according to the known



perceived loudness of the human ear at each frequency and is given a phon value. The phons can then be used to calculate the more linear sone value.

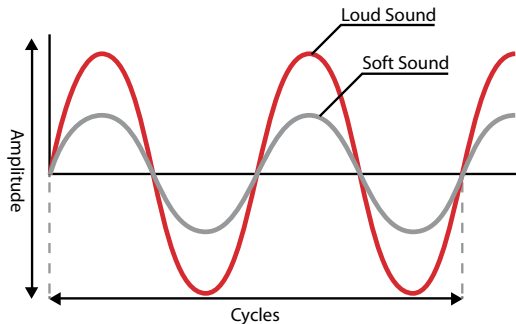

LOUDSPEAKER

A transducer that converts an electrical source signal into sound with the combination of an electro-magnetic device coupled with a diaphragm, similar to the design of a microphone, only a loudspeaker radiates acoustic energy rather than receiving it. Loudspeakers are most commonly used to reproduce speech and music. Field and laboratory sound testing often requires the use of loudspeakers to generate noise.

MASS

The property of an object, measured in grams, that is determined by its resistance to acceleration by a given force. Mass is not the same as weight.

MICROPHONE

A transducer or sensor that converts incoming sound waves into an electrical signal. Sound waves incident on the microphone diaphragm are converted into equivalent fluctuations in an electric signal that is transmitted to a measurement device or audio converter.

NOISE CRITERIA (NC)

A single-number metric that is used to rate the interior noise levels in enclosed spaces. The NC is calculated by fitting the interior Sound Pressure Level (SPL) measurement data to a set of predefined NC curves over a specified frequency range: from 63 Hz to 8,000 Hz. The value of the lowest NC curve that the SPL measurement data does not exceed is reported as the NC value of the enclosure.

NOISE

Unwanted sound. Noise is caused by numerous sound sources such as air handling equipment, construction equipment and machinery, and even computers and electric lighting. It has been known to cause increases in heart rate and stress levels, especially in the work place. "Noise pollution" is a term and is becoming common, as population density and industry rises.

NOISE REDUCTION COEFFICIENT (NRC)

A single-number rating that is related to the sound absorption of materials and surfaces. NRC values approaching zero characterize highly reflective surfaces and NRC values approaching or exceeding one characterize highly absorptive surfaces.

OCTAVE

The interval between two frequencies, based on a power of two. In music, the most common note used for tuning an orchestra is an A at 440 Hz. The A-note one octave higher is found at 880 Hz, twice the value of A at 440 Hz, while the A-note that is one octave lower will be found at 220 Hz. A major scale is typically written using eight notes with the interval between the first and last notes as one octave, or twice the frequency value.

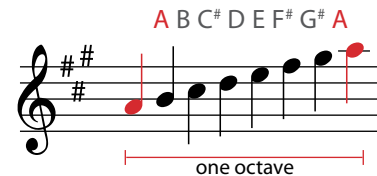

1/3 OCTAVE

Similar to an octave-band measurement, but with two additional measured frequencies per octave. Whereas an octave-band measurement will be made at frequencies such as 125, 250, 500, and 1,000 Hz, the same measurement frequency range in one-third octave bands will have data at 125, 160, 200, 250, 315, 400, 500, 630, 800, and 1,000 Hz. For example, one-third points would approximate:

Note	Note Frequency (Hz)	Testing Frequency (Hz)
G2	98.0	100
B2	123.5	125
D#3	155.6	160
G3	196.0	200

OUTDOOR-INDOOR TRANSMISSION CLASS (OITC)

A laboratory and field metric that is used to characterize and rate the transmission of sound through exterior building facades and other elements. The OITC is measured and calculated from an A-weighted Sound Pressure Level (SPL) measurement of the sound source outside the building facade and the Sound Transmission Loss (STL), Outdoor-Indoor Transmission Loss (OITL), or Apparent Outdoor-Indoor Transmission Loss (AOITL).

REFLECTION

The physical phenomena that occurs when energy incident upon any surface or barrier is propagated back in the opposite direction of the incident energy. For sound in buildings, reflection is the propagation of a sound wave back into the enclosed space, resulting in **reverberation**.

REVERBERATION

The echo-effect in enclosures or acoustically reflective environments wherein sound is reflected from rigid or semi-rigid surfaces such as interior building partitions and concrete barriers. Reverberation Time (T60) is measured in seconds and, for building noise control measurements, is the amount of time it takes for the Sound Pressure Level (SPL) at each frequency to drop by 60 dB.



SHEAR

The deformation of solid objects such as beams, panels, and plates that occurs when one side of the material is forced in one direction and a parallel side simultaneously experiences an equal force that causes it to remain rigid. For example, when a foam pad is rigidly glued to a plywood sub-floor and a child attempts to slide across the floor on the foam, the foam will undergo a shear deformation wherein the side of the foam that is glued to the sub-floor remains rigid and the surface of the foam where the child is sliding will move in the same direction as the child. Gypsum wallboard panels that are rigidly attached to assembly partition framing experience shear deformation in the presence of sound waves.

SHORT CIRCUIT

The unintended contact of mechanical or electrical components that results in the transfer of energy directly through electrical circuitry or mechanically coupled structures.

In the case of building noise control, short-circuiting through resilient channels (RC) or other isolating components results in a partial or even full (if extreme) failure of the assembly to effectively isolate sound between rooms.

SOUND

The audible result of a pressure wave that is transmitted through a medium such as air or water; caused by the vibration of solid materials or turbulent fluctuations in air and other gases.

SOUND PRESSURE LEVEL (SPL)

Measurement of radiated sound pressure, in dB, usually by a microphone.

SOUND TRANSMISSION LEVEL (STL)

A laboratory measurement, in dB, of the transmitted Sound Pressure Level (SPL) through a partition dividing two spaces.

SOUNDPROOF

A commonly-used term that usually implies an intent to provide additional sound isolation to a partition, room, barrier, or building. Technically, the word "soundproof" is indicative of the absence of all sound, including ambient noise: a completely unattainable goal.

Building partitions can, however, be built with an acceptable degree of sound isolation.

SPEECH PRIVACY CLASS (SPC)

A laboratory or field metric that is calculated based on a measurement of the sound transmission loss between two enclosed rooms as well as the background noise.

For laboratory measurements, the SPC is calculated by arithmetically averaging the Sound Transmission Loss (STL) of the laboratory assembly partition from 160 Hz to 5,000 Hz and assuming an average background noise level based on either project-related background noise data for the partition in concern or on a standard background level cited in current research documents.

The average STL is then added to the average background noise level, plus one, for the Speech Privacy Class (SPC) result.

In the field, the SPC calculation is based on the measurement of the STL between two enclosed spaces for multiple noise source (loudspeaker) locations and at multiple locations within the receiving room, or the room

on the other side of the partition from the source room. The background noise level is then measured at each of the microphone locations. The STL and background noise levels are averaged between all loudspeaker and microphone locations and then, similar to the laboratory calculation, the SPC is calculated as the sum of the arithmetically-averaged STL and background noise level from 160 Hz to 5,000 Hz.

TRANSMISSION

The transfer of energy from point to another through a barrier. Transmitted sound in buildings is primarily caused by:

Airborne noise - human speech, television, home theater systems, and the like cause sound pressure waves in the air that transmit through partitions.

Impact noise - high heel noise, closing cupboards, machinery, and other collision- or contact-based noise sources result in structural vibration that transmits through partitions via framing and other rigid connections.

Flanking noise - any airborne or impact noise transmitted from one space to another indirectly (not directly through the partition itself) such as through continuous sub-floors, window mullions, and open plenum ceilings.

METRIC CONVERSIONS

Gypsum Panel Product Thickness

1/4 inch - 6.4 mm
3/8 inch - 9.5 mm
1/2 inch - 12.7 mm
5/8 inch - 15.9 mm
3/4 inch - 19.0 mm
1 inch - 25.4 mm

Framing Spacing

8 inch - 203 mm
12 inch - 305 mm
16 inch - 406 mm
24 inch - 610 mm

Fastener Spacing

2 inch - 51 mm
2-1/2 inch - 64 mm
7 inch - 178 mm
8 inch - 203 mm
12 inch - 305 mm
16 inch - 406 mm
24 inch - 610 mm

Temperature

40°F - 5°C
50°F - 10°C
125°F - 52°C

Legal Notices & Warranty Information

LIMITED WARRANTY:

PABCO® Building Products, LLC, warrants that on the date the gypsum board is shipped from its manufacturing plant the gypsum board is free from defects in materials and manufacture. **NOTWITHSTANDING THE FOREGOING, IT IS THE RESPONSIBILITY OF THE GYPSUM BOARD APPLICATOR TO NOTIFY PABCO® BUILDING PRODUCTS, LLC, IN WRITING WITHIN TWENTY FOUR (24) HOURS OF DISCOVERY OF ANY VISIBLY DEFECTIVE GYPSUM BOARD PRIOR TO SUCH VISIBLY DEFECTIVE GYPSUM BOARD BEING APPLIED; FAILURE TO DO SO MAY FURTHER LIMIT OR VOID THE RESPONSIBILITIES OF PABCO® BUILDING PRODUCTS, LLC, UNDER THIS WARRANTY.** This warranty will remain in place for one year from the date of shipment from the manufacturing plant. **THIS EXPRESS WARRANTY IS THE EXCLUSIVE WARRANTY PROVIDED BY PABCO® BUILDING PRODUCTS, LLC, AND SUPERSEDES ANY PRIOR, CONTRARY OR ADDITIONAL REPRESENTATIONS, WHETHER ORAL OR WRITTEN. PABCO® BUILDING PRODUCTS, LLC, HEREBY DISCLAIMS AND EXCLUDES ALL OTHER WARRANTIES – WHETHER EXPRESS, IMPLIED, OR STATUTORY – INCLUDING ANY WARRANTY OF MERCHANTABILITY, ANY WARRANTY OF FITNESS FOR A PARTICULAR PURPOSE, AND ANY IMPLIED WARRANTIES OTHERWISE ARISING FROM COURSE OF DEALING OR USAGE OF TRADE.**

If the gypsum board fails to conform to the foregoing warranty in Paragraph 1 and such nonconformity is not due to misuse or improper maintenance or storage, Buyer shall notify PABCO® Building Products, LLC, in writing, and within 60 days of discovery, PABCO® Building Products, LLC, shall provide, at its sole and absolute discretion, one of the following: (i) repair or replacement of any nonconforming or defective gypsum wallboard; or (ii) credit or full refund of the purchase price. **THIS REMEDY SHALL BE THE EXCLUSIVE AND SOLE REMEDY OF BUYER FOR ANY BREACH OF WARRANTY.**

IN NO EVENT SHALL PABCO® BUILDING PRODUCTS, LLC, BE LIABLE FOR ANY INCIDENTAL, SPECIAL, INDIRECT, OR CONSEQUENTIAL DAMAGES, WHETHER RESULTING FROM NONDELIVERY OR FROM THE USE, MISUSE, OR INABILITY TO USE THE PRODUCT OR FROM DEFECTS IN THE PRODUCT OR FROM NEGLIGENCE OR OTHER TORT. This exclusion applies regardless of whether such damages are sought for breach of warranty, breach of contract, negligence, or strict liability in tort or under any other legal theory.

TRADEMARKS:

The following trademarks used herein are owned by Pacific Coast Building Products and licensed to PABCO® Gypsum: PABCO®, what the job demands™, PABCO LITECORE®, FLAME CURB®, ABUSE CURB®, WATER CURB®, PABCORE®, PABCO GLASS®, MOLD CURB® Plus, Quality to the Core®, QuietRock®, EZ-SNAP™, QuietPutty®, QuietSeal® Pro, QuietGlue® Pro, QuietCoat®, QuietSeam® and Quiet®.

PRODUCT AVAILABILITY:

Products described herein may not be available in all geographic markets. Special lengths may be available on a special order basis. Consult your PABCO® Gypsum sales representative for information.

CURRENT UPDATED INFORMATION:

Additional and updated information is available on our websites: www.PABCOgypsum.com and www.QuietRock.com. The information in this publication may change without notice.



HOME QUIET[®] HOME

Homes are increasingly becoming multi-functional spaces. Whether working in a home office or enjoying a surround sound home theater, there is a greater need for sound control in the home.

STOP the **SOUND** transfer from room to room with **QUIETROCK[®] SOUND REDUCING DRYWALL**.



QuietRock[®]
by PABCO Gypsum

- High acoustic performance
- Easy installation
- Low installed cost
- Saves floor space
- Ideal for remodels-no demolition required

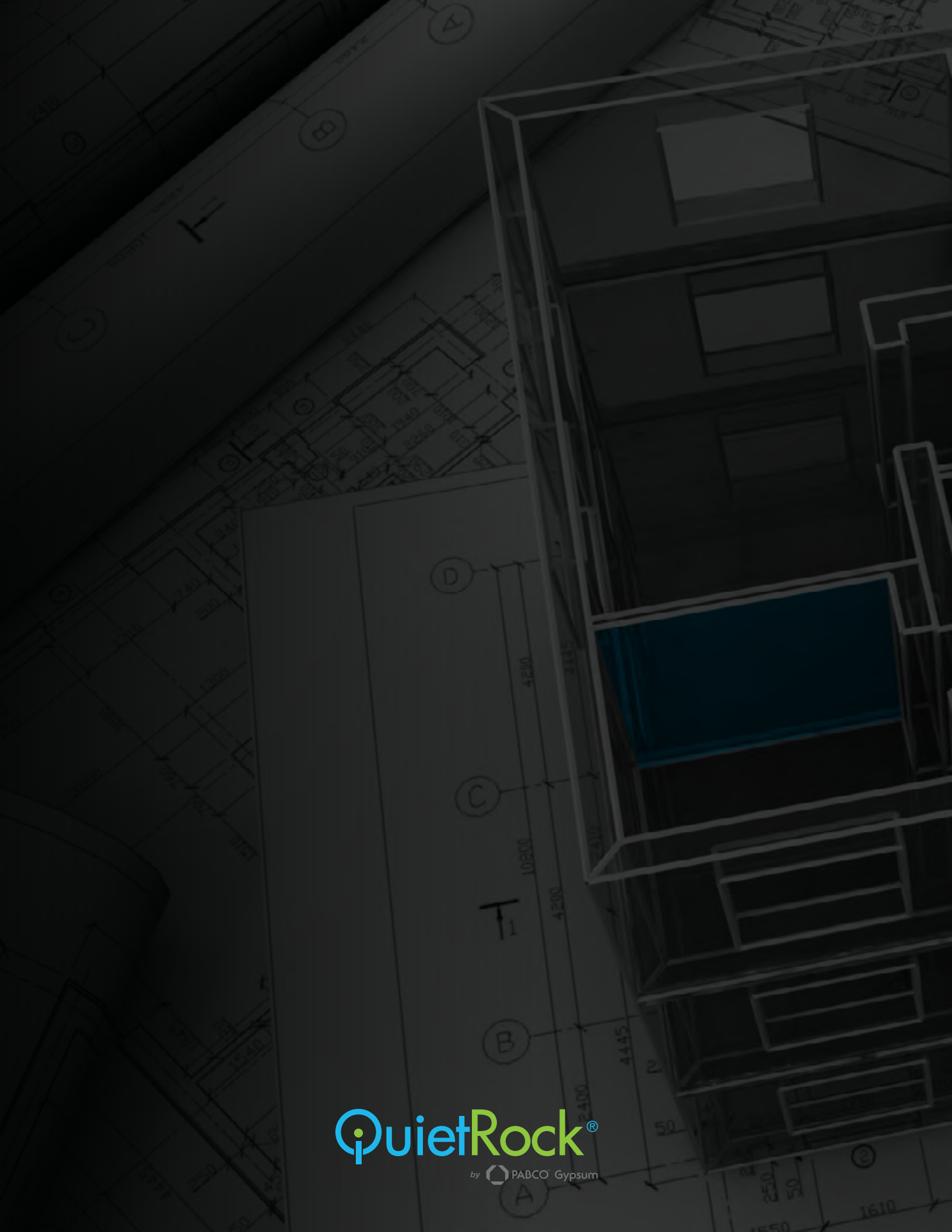

QuietRock®

by PABCO Gypsum